

# Canon

## Multimedia Projector

# LV-S4

### Owner's Manual



**E**  
English

# Features and Design

---

This Multimedia Projector is designed with the most advanced technology for portability, durability, and ease of use. This projector utilizes built-in multimedia features, a palette of 16.77 million colors, and matrix liquid crystal display (LCD) technology.

## ◆ **Compact Design**

---

This projector is designed compact in size and weight. It is easy to carry and work anywhere you wish to use.

## ◆ **Compatibility**

---

The projector widely accepts various video and computer input signals including; Computers, 6 Color systems (PAL, SECAM, NTSC, NTSC4.43, PAL-M, PAL-N), Component Video, S-video and RGB scart.

## ◆ **Simple Computer System Setting**

---

The projector has the Multi-scan system to conform to almost all computer output signals quickly. (See page 25.)

## ◆ **Auto PC Adjustment**

---

Incoming computer signals are recognized and the best adjustment is automatically set by the Auto PC Adjustment. No complicated setup is necessary and the projection is always precise. ( See page 26. )

## ◆ **Blackboard Function**

---

A blackboards\* can be used as a projection screen.

\*The board color is limited to Green.

(See page 29 and 34)

## ◆ **Digital Zoom (for Computer)**

---

The Digital zoom function expands (to approx. 16 times of screen size) or compresses the image size, allowing you to focus on crucial information at a presentation. (See page 31.)

## ◆ **Film Function**

---

The Film function reproduces pictures faithful to the original film quality from 3-2 pull-down video contents. (See page 36.)

## ◆ **Multi-Language Menu Display**

---

Operation menu is available in 12 languages; English, German, French, Italian, Spanish, Portuguese, Dutch, Swedish, Russian, Chinese, Korean, or Japanese. (See page 38.)

## ◆ **Keystone Adjustment**

---

The keystone correction function is provided to correct distortion of the projected image allowing you to use the projector without locational constraints.

(See page 22 and 38.)

## ◆ **Power Management Function**

---

The Power management function reduces power consumption and maintains the lamp life. (See page 41.)

## ◆ **User's Logo**

---

A projected image can be captured and used for the starting display of the projector with the Capture function. You can also display the captured image in an interval during your presentation instead of blackout the image with the No show function. (See page 22 and 40.)

## ◆ **Selectable Lamp Mode**

---

Brightness of the projection lamp can be selected in the Setting menu. (See page 41.)

## ◆ **Key Lock Function**

---

Provided to lock the operation of the projector. This function protects the projector from being tampered with by third persons. (See page 42)

## ◆ **PIN Code Lock Function**

---

The PIN code lock function prevents others except users from using the projector. (See page 17 and 43.)

# Table of Contents

<b>Features and Design</b> .....	<b>2</b>	<b>Computer Input</b> .....	<b>24</b>
<b>Table of Contents</b> .....	<b>3</b>	Input Source Selection	24
<b>To the Owner</b> .....	<b>4</b>	Computer System Selection	25
<b>Safety Instructions</b> .....	<b>5</b>	Auto PC Adjustment	26
Air Circulation	6	Manual PC Adjustment	27
Installing the Projector in Proper Position	6	Image Level Selection	29
Moving the Projector	6	Image Level Adjustment	30
<b>Compliance</b> .....	<b>7</b>	Screen Size Adjustment	31
<b>Part Names and Functions</b> .....	<b>8</b>	<b>Video Input</b> .....	<b>32</b>
Front	8	Input Source Selection	32
Back	8	Video System Selection	33
Bottom	8	Image Level Selection	34
Rear Terminal	9	Image Level Adjustment	35
Top Control	10	Screen Size Adjustment	37
Remote Control Unit	11	<b>Setting</b> .....	<b>38</b>
Operating Range	11	Setting	38
Remote Control Unit Battery Installation	12	<b>Maintenance and Cleaning</b> .....	<b>45</b>
<b>Installation</b> .....	<b>13</b>	Warning Indicator	45
Positioning the Projector	13	Cleaning the Air Filters	46
Adjustable Feet	13	Cleaning the Projection Lens	47
Connecting the AC Power Cord	14	Cleaning the Projector Cabinet	47
Connecting to a Computer	15	Attaching the Lens Cover	47
Connecting to Video Equipment	16	Lamp Replacement	48
<b>Basic Operation</b> .....	<b>17</b>	Lamp Replace Counter	49
Turning On the Projector	17	<b>Appendix</b> .....	<b>50</b>
Turning Off the Projector	18	Troubleshooting	50
Zoom and Focus Adjustment	19	Menu Tree	52
How to Operate the On-Screen Menu	20	Indicators and Projector Condition	54
Menu Bar	21	Compatible Computer Specifications	55
Keystone Adjustment	22	Technical Specifications	56
Picture Freeze Function	22	Optional Parts	57
No Show Function	22	Configurations of Terminals	58
P-Timer Function	23	PIN code label	59
Sound Adjustment	23		

---

## Trademarks

Each name of corporations or products in this book is either a registered trademark or a trademark of its respective corporation.





# To the Owner

Before operating this projector, read this manual thoroughly and operate the projector properly.

This projector provides many convenient features and functions. Operating the projector properly enables you to manage those features and maintains it in better condition for a considerable time.

Improper operation may result in not only shortening the product-life, but also malfunctions, fire hazard, or other accidents.

If your projector seems to operate improperly, read this manual again, check operations and cable connections and try the solutions in the "Troubleshooting" section in the end of this booklet. If the problem still persists, contact the dealer where you purchased the projector or the service center.

	<b>CAUTION</b> <b>RISK OF ELECTRIC SHOCK</b> <b>DO NOT OPEN</b>	
<b>CAUTION :</b> TO REDUCE THE RISK OF ELECTRIC SHOCK, DO NOT REMOVE COVER (OR BACK). NO USER-SERVICEABLE PARTS INSIDE EXCEPT LAMP REPLACEMENT. REFER SERVICING TO QUALIFIED SERVICE PERSONNEL.		
	THIS SYMBOL INDICATES THAT DANGEROUS VOLTAGE CONSTITUTING A RISK OF ELECTRIC SHOCK IS PRESENT WITHIN THIS UNIT.	
	THIS SYMBOL INDICATES THAT THERE ARE IMPORTANT OPERATING AND MAINTENANCE INSTRUCTIONS IN THE OWNER'S MANUAL WITH THIS UNIT.	

## CAUTION

Not for use in a computer room as defined in the Standard for the Protection of Electronic Computer/Data Processing Equipment, ANSI/NFPA 75.

Ne peut être utilisé dans une salle d'ordinateurs telle que définie dans la norme ANSI/NFPA 75 Standard for Protection of Electronic Computer/Data Processing Equipment



## Safety Precaution

**WARNING :** TO REDUCE THE RISK OF FIRE OR ELECTRIC SHOCK, DO NOT EXPOSE THIS APPLIANCE TO RAIN OR MOISTURE.

- This projector produces intense light from the projection lens. Do not stare directly into the lens as possible. Eye damage could result. Be especially careful that children do not stare directly into the beam.
- Install the projector in a proper position. If not, it may result in a fire hazard.
- Provide appropriate space on the top, sides and rear of the projector cabinet for allowing air circulation and cooling the projector. Minimum clearance must be maintained. If the projector is to be built into a compartment or similarly enclosed, the minimum distances must be maintained. Do not cover the ventilation slot on the projector. Heat build-up can reduce the service life of your projector, and can also be dangerous.

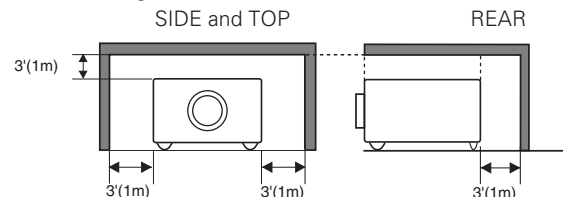

- Do not put any flammable object or spray can near the projector, hot air is exhausted from the ventilation holes.
- If the projector is not to be used for an extended time, unplug the projector from the power outlet.

**READ AND KEEP THIS OWNER'S MANUAL FOR LATER USE.**

## NOTE FOR CUSTOMERS IN THE US

 LAMP(S) INSIDE THIS PRODUCT CONTAIN MERCURY AND MUST BE RECYCLED OR DISPOSED OF ACCORDING TO LOCAL, STATE OR FEDERAL LAWS.

# Safety Instructions

All the safety and operating instructions should be read before the product is operated.

Read all of the instructions given here and retain them for later use. Unplug this projector from AC power supply before cleaning. Do not use liquid or aerosol cleaners. Use a damp cloth for cleaning.

Follow all warnings and instructions marked on the projector.

For added protection to the projector during a lightning storm, or when it is left unattended and unused for long periods of time, unplug it from the wall outlet. This will prevent damage due to lightning and power line surges.

---

Do not expose this unit to rain or use near water... for example, in a wet basement, near a swimming pool, etc...

Do not use attachments not recommended by the manufacturer as they may cause hazards.

Do not place this projector on an unstable cart, stand, or table. The projector may fall, causing serious injury to a child or adult, and serious damage to the projector. Use only with a cart or stand recommended by the manufacturer, or sold with the projector. Wall or shelf mounting should follow the manufacturer's instructions, and should use a mounting kit approved by the manufacturers.

An appliance and cart combination should be moved with care. Quick stops, excessive force, and uneven surfaces may cause the appliance and cart combination to overturn.



---

Slots and openings in the back and bottom of the cabinet are provided for ventilation, to ensure reliable operation of the equipment and to protect it from overheating.

The openings should never be covered with cloth or other materials, and the bottom opening should not be blocked by placing the projector on a bed, sofa, rug, or other similar surface. This projector should never be placed near or over a radiator or heat register.

This projector should not be placed in a built-in installation such as a book case unless proper ventilation is provided.

Never push objects of any kind into this projector through cabinet slots as they may touch dangerous voltage points or short out parts that could result in a fire or electric shock. Never spill liquid of any kind on the projector.

Do not install the projector near the ventilation duct of air-conditioning equipment.

This projector should be operated only from the type of power source indicated on the marking label. If you are not sure of the type of power supplied, consult your authorized dealer or local power company.

Do not overload wall outlets and extension cords as this can result in fire or electric shock. Do not allow anything to rest on the power cord. Do not locate this projector where the cord may be damaged by persons walking on it.

Do not attempt to service this projector yourself as opening or removing covers may expose you to dangerous voltage or other hazards. Refer all servicing to qualified service personnel.

Unplug this projector from wall outlet and refer servicing to qualified service personnel under the following conditions:

- a. When the power cord or plug is damaged or frayed.
- b. If liquid has been spilled into the projector.
- c. If the projector has been exposed to rain or water.
- d. If the projector does not operate normally by following the operating instructions. Adjust only those controls that are covered by the operating instructions as improper adjustment of other controls may result in damage and will often require extensive work by a qualified technician to restore the projector to normal operation.
- e. If the projector has been dropped or the cabinet has been damaged.
- f. When the projector exhibits a distinct change in performance-this indicates a need for service.

When replacement parts are required, be sure the service technician has used replacement parts specified by the manufacturer that have the same characteristics as the original part. Unauthorized substitutions may result in fire, electric shock, or injury to persons.

Upon completion of any service or repairs to this projector, ask the service technician to perform routine safety checks to determine that the projector is in safe operating condition.

## **Air Circulation**

Openings in the cabinet are provided for ventilation and to ensure reliable operation of the product and to protect it from overheating, and these openings must not be blocked or covered.

### **CAUTION**

Hot air is exhausted from the exhaust vent. When using or installing the projector, the following precautions should be taken.

- Do not put any flammable objects near the vent.
- Keep the exhaust vent at least 3'(1m) away from any objects.
- Do not touch a peripheral part of the exhaust vent, especially screws and metallic part. This area will become hot while the projector is being used.
- Do not put anything on the projector. The materials put on the cabinet will not only get damaged but also cause fire hazard by heat.

Cooling fans are provided to cool down the projector. This projector monitors internal temperature and control the running speed of the cooling fans.

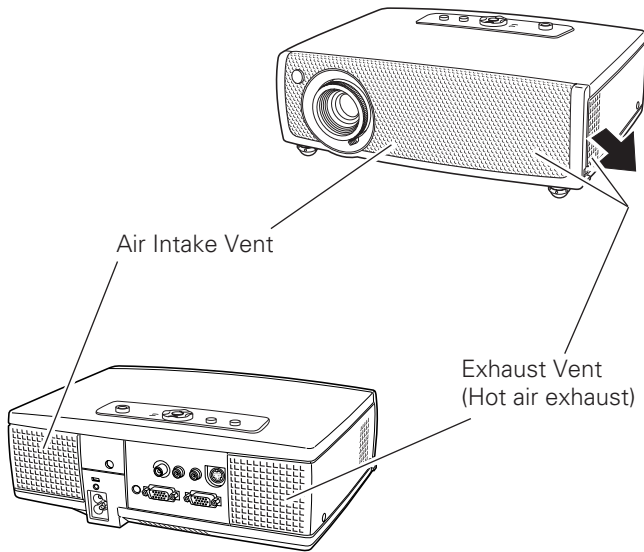

## **Installing the Projector in Proper Position**

Install the projector properly. Improper Installation may reduce the lamp life and cause a fire hazard.

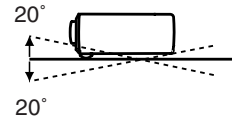

Do not tilt the projector more than 20 degrees above and below.



Do not point the projector up to project an image.



Do not point the projector down to project an image.



Do not put the projector on either side to project an image.

## **Moving the Projector**

When moving the projector, replace the Lens Cover and retract Adjustable Feet to prevent damage to the lens and cabinet.

When the projector is not in use for an extended period, put it into the supplied case (carrying bag) with lens side up.

### **CAUTION**

Carrying Bag (supplied) is intended for protection from dust and scratches on the surface of a cabinet, and it is not designed to protect an appliance from external forces. Do not transport the projector through a courier or transport services with this bag, otherwise the projector can be damaged. When handling the projector, do not drop, bump, subject it to strong forces or put other things on the cabinet.

### **USE CAUTION IN CARRYING OR TRANSPORTING THE PROJECTOR**

- Do not drop or bump the projector, otherwise damages or malfunctions may result.
- When carrying the projector, use a suitable carrying case.
- Do not transport the projector by using a courier or transport service in an unsuitable transport case. This may cause damage to the projector. To transport a projector through a courier or transport service, consult your dealer for their information.

## **Federal Communication Commission Notice**

Multimedia Projector, Model : LV-S4E and LV-S4U

This device complies with Part 15 of the FCC Rules. Operation is subject to the following two conditions:

- (1) This device may not cause harmful interference, and
- (2) this device must accept any interference received, including interference that may cause undesired operation.

Note : This equipment has been tested and found to comply with the limits for a Class B digital device, pursuant to part 15 of the FCC Rules. These limits are designed to provide reasonable protection against harmful interference in a residential installation. This equipment generates, uses and can radiate radio frequency energy and, if not installed and used in accordance with the instructions, may cause harmful interference to radio communications. However, there is no guarantee that interference will not occur in a particular installation. If this equipment does cause harmful interference to radio or television reception, which can be determined by turning the equipment off and on, the user is encouraged to try to correct the interference by one or more of the following measures :

- Reorient or relocate the receiving antenna.
- Increase the separation between the equipment and receiver.
- Connect the equipment into an outlet on a circuit different from that to which the receiver is connected.
- Consult the dealer or an experienced radio/TV technician for help.

Use of shielded cable is required to comply with class B limits in Subpart B of Part 15 of FCC Rules.

Do not make any changes or modifications to the equipment unless otherwise specified in the manual. If such changes or modifications should be made, you could be required to stop operation of the equipment.

Canon U.S.A., Inc.  
One Canon Plaza, Lake Success, NY 11042, U.S.A.  
Tel No. (516)328-5600

## **Canadian Radio Interference Regulations**

This Class B digital apparatus complies with Canadian ICES-003.

### **Réglementation canadienne sur les interférences radio**

Cet appareil numérique de la classe B est conforme à la norme NMB-003 du Canada.

## **AC Power Cord Requirement**

The AC Power Cord supplied with this projector meets the requirement for use in the country you purchased it.

### **AC Power Cord for the United States and Canada :**

AC Power Cord used in the United States and Canada is listed by the Underwriters Laboratories (UL) and certified by the Canadian Standard Association (CSA).

AC Power Cord has a grounding-type AC line plug. This is a safety feature to be sure that the plug will fit into the power outlet. Do not try to defeat this safety feature. Should you be unable to insert the plug into the outlet, contact your electrician.

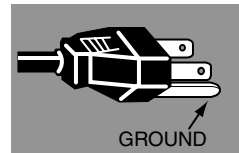

**THE SOCKET-OUTLET SHOULD BE INSTALLED NEAR THE EQUIPMENT AND EASILY ACCESSIBLE.**

# Part Names and Functions

## Front

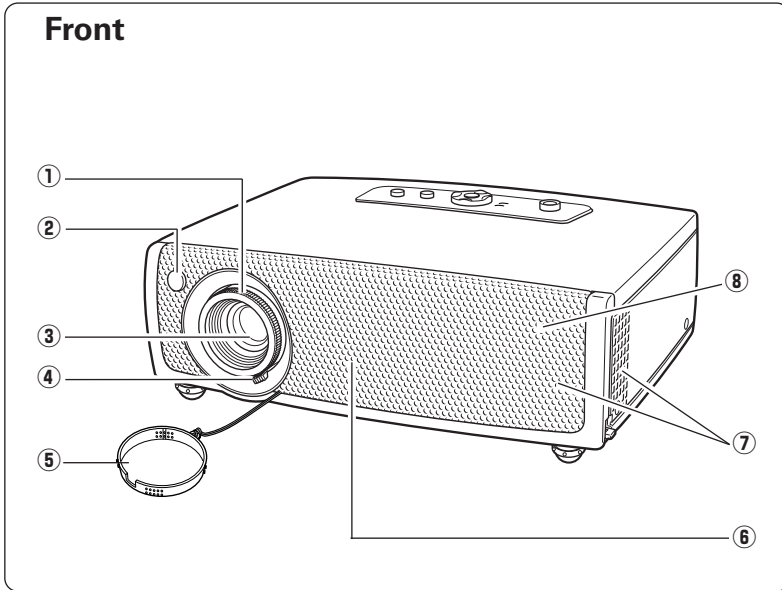

- ① Focus Ring
- ② Infrared Remote Receiver
- ③ Projection Lens
- ④ Zoom Lever
- ⑤ Lens Cover
- ⑥ Air Intake Vent
- ⑦ Exhaust Vent



Hot air is exhausted from the exhaust vent. Do not put heat-sensitive objects near this side.

- ⑧ Speaker

## Back

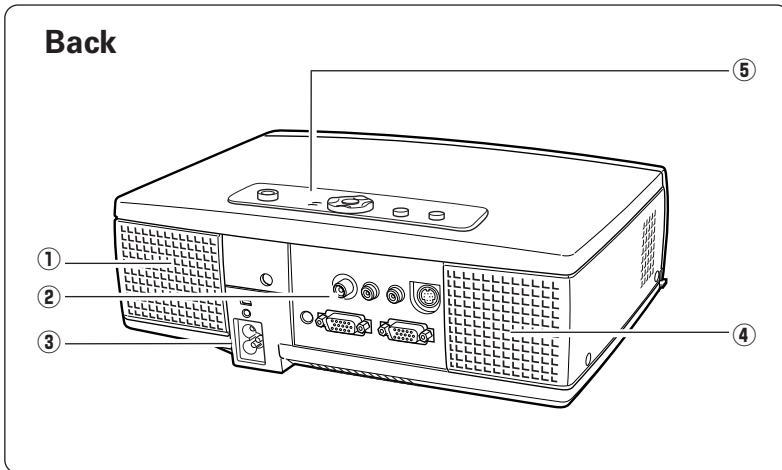

- ① Air Intake Vent
- ② Terminals and Connectors
- ③ Power Cord Connector
- ④ Exhaust Vent
- ⑤ Top Controls and Indicators



Hot air is exhausted from the exhaust vent. Do not put heat-sensitive objects near this side.

## Bottom

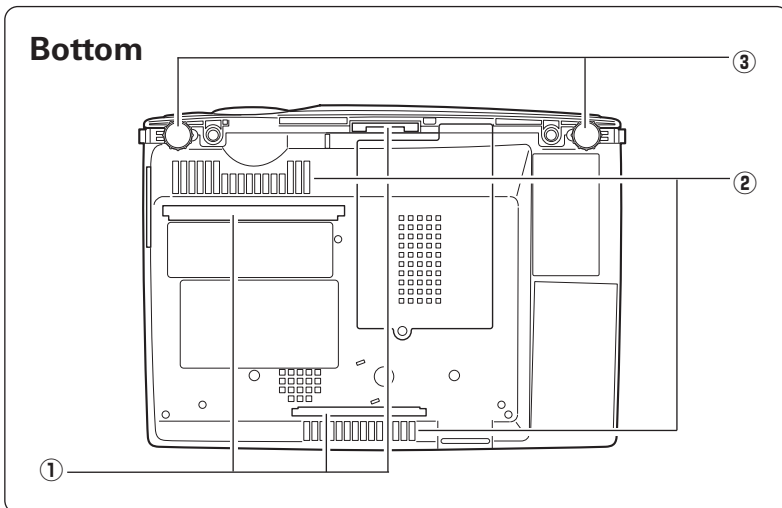

- ① Air Filters
- ② Air Intake Vents
- ③ Adjustable Feet



Hot air is exhausted from the exhaust vents. When using or installing the projector, the following precautions should be taken.

- Do not put any flammable objects near these vents.
- Keep front grills at least 3'(1m) away from any objects, especially heat-sensitive objects.
- Do not touch this area, especially screws and metallic part. This area will become hot while the projector is being used.

This projector detects internal temperature and will automatically adjust the running speed of the cooling fans.



## Rear Terminal

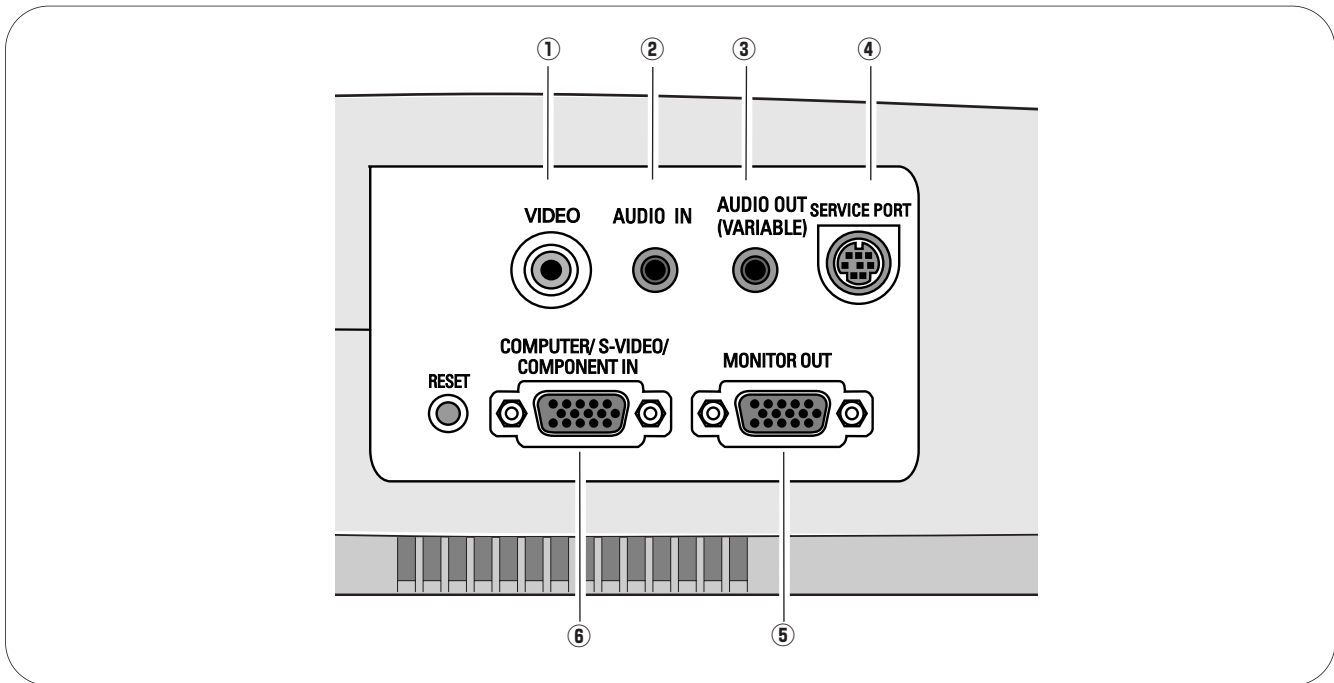

- ① **VIDEO**  
Connect the composite video output from video equipment to VIDEO jack. (p16)
- ② **AUDIO IN (Stereo)**  
Connect the audio output from computer or video equipment connected to ① or ⑥ to this jack. (p15, 16)
- ③ **AUDIO OUT(VARIABLE)**  
Connect an external audio amplifier to this jack. (p15, 16)  
This terminal outputs sound from AUDIO IN terminal.
- ④ **SERVICE PORT**  
This jack is used to service this projector.
- ⑤ **MONITOR OUT**  
This terminal outputs the signal coming from COMPUTER / S-VIDEO / COMPONENT IN terminal. (This terminal cannot output RGB(Scart) signal from COMPUTER / S-VIDEO / COMPONENT IN terminal.) (p15)
- ⑥ **COMPUTER / S-VIDEO / COMPONENT IN**  
Connect S-video output, RGB Scart 21-pin video output, component video output or computer output to this connector. (p15,16)

\* A built-in micro processor which controls this unit may occasionally malfunction and need to be reset. This can be done by pressing the RESET button with a pen, which will shut down and restart the unit. Do not use the RESET function excessively.

✓ **Note:**

- Audio out and Monitor out terminal works only when the projector is under operation and do not work when the projector is in stand-by state or Power management mode (p41).

## Top Control

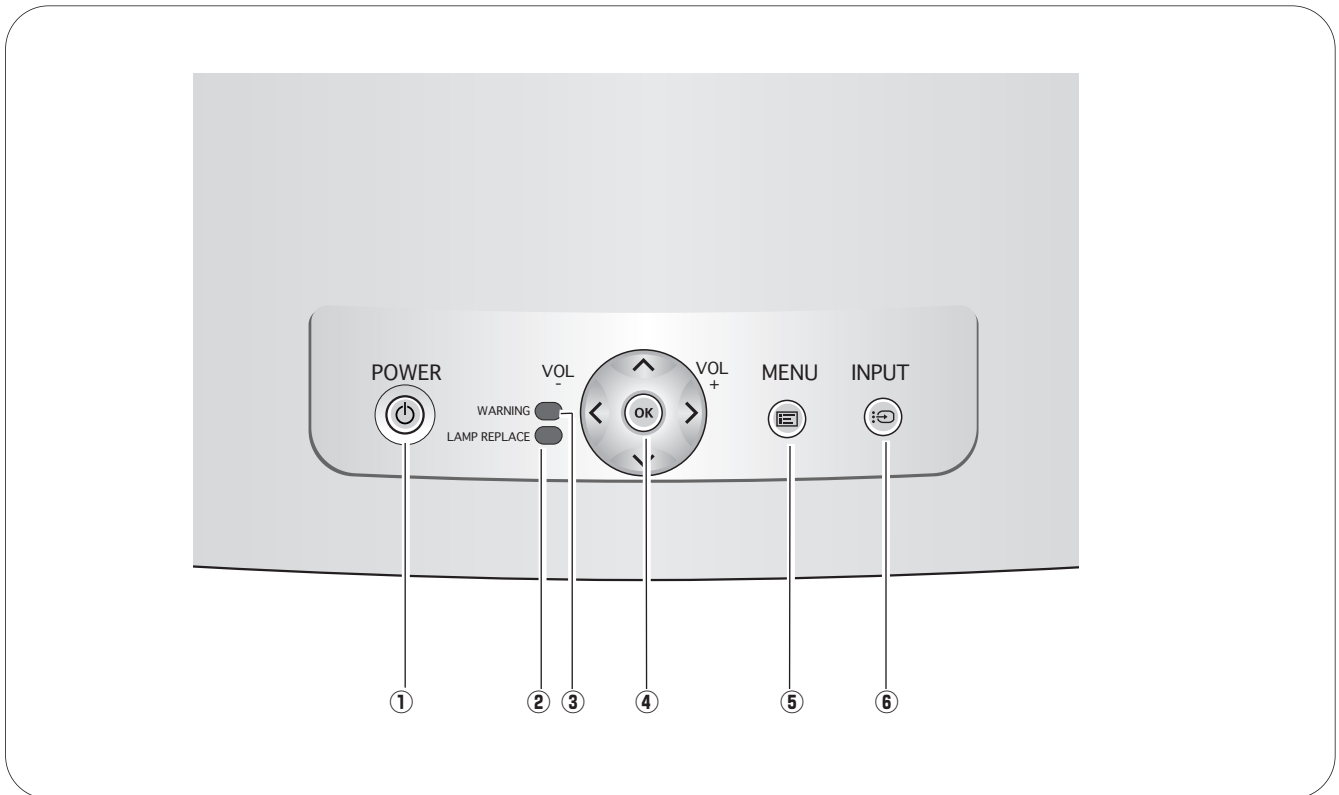

① **POWER button**

Turn the projector on or off. (p17, 18)

**POWER indicator**

Flash red until the projector gets ready to be turned on. It turns red when the projector is in the stand-by mode. It remains green while the projector is under operation. (p17, 18, 54)

② **LAMP REPLACE indicator**

Turn yellow when the life of the projection lamp draws to an end. (p48, 54)

③ **WARNING indicator**

Emit red light when the projector is in the abnormal condition. This indicator also flashes red when the internal projector temperature goes up over the operating range. (p45, 54)

④ **OK button**

Execute the item selected. It is also used to expand/compress the image in Digital zoom +/- mode. (p31)

**Point ▲▼◀▶ (VOL +/-) button**

Select an item or adjust the value in the On-Screen Menu. These are also used to pan the image in the Digital zoom + mode. (p31)

Point ◀▶ button are also used as VOL +/- button. (p23)

⑤ **MENU button**

Open or close the On-Screen Menu. (p20)

⑥ **INPUT button**

Select the input source. (p24, 32)

## Remote Control Unit

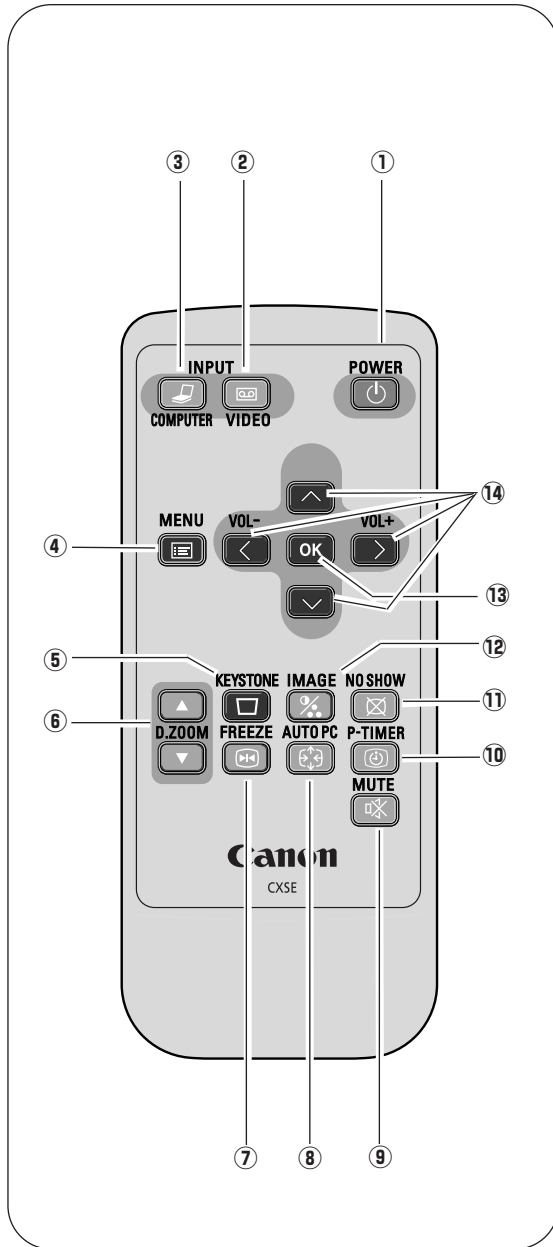

- ① **POWER button**  
Turn the projector on or off. (p17, 18)
- ② **VIDEO button**  
Select the VIDEO input. (p32)
- ③ **COMPUTER button**  
Select the COMPUTER input source. (p24, 32)
- ④ **MENU button**  
Open or close the On-Screen Menu. (p20)
- ⑤ **KEystone button**  
Correct the keystone distortion. (p22, 38)
- ⑥ **D.ZOOM ▲▼ buttons**  
Select the Digital zoom +/- mode and resize the image. (p31)
- ⑦ **FREEZE button**  
Freeze the picture. (p22)
- ⑧ **AUTO PC button**  
Automatically adjust the computer image to its optimum setting. (p26)
- ⑨ **MUTE button**  
Mute the sound. (p23)
- ⑩ **P-TIMER button**  
Operate the P-timer function. (p23)
- ⑪ **NO SHOW button**  
Temporarily turn off the image on the screen. (p22)
- ⑫ **IMAGE button**  
Select the image level. (p29, 34)
- ⑬ **OK button**  
Execute the selected item, or to expand or compress the image in Digital zoom +/- mode. (p31)
- ⑭ **Point ▲▼◀▶ (VOL +/-) buttons**  
Select an item or adjust the value in the On-Screen Menu. These are also used to pan the image in the Digital zoom + mode. (p31)  
Point ◀▶ buttons are also used as VOL +/- mode. (p23)

✓ **Note:**

- See p42 for changing the remote control unit code.

## Operating Range

Point the remote control unit toward the projector (Infrared Remote Receiver) whenever pressing any button. Maximum operating range for the remote control unit is about 16.4' (5m) and 60° in front of the projector.

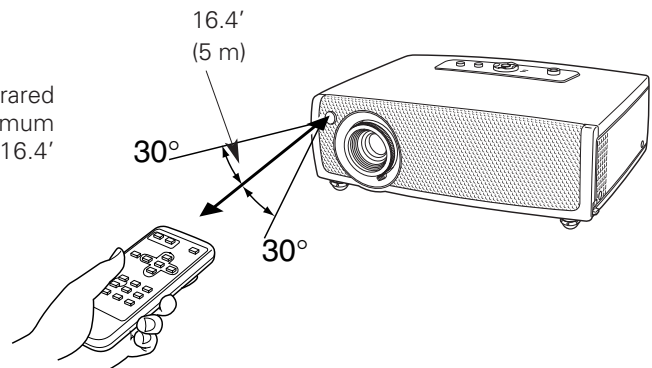

## Remote Control Unit Battery Installation

- 1** Remove the battery compartment lid.

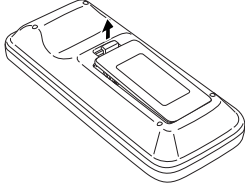

- 2** Slide the batteries into the compartment.

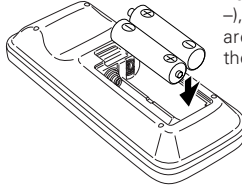

**Two AAA size batteries**  
For correct polarity (+ and -), be sure battery terminals are in contact with pins in the compartment.

- 3** Replace the compartment lid.

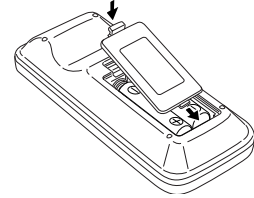

To insure safe operation, please observe the following precautions :

- Use (2) AAA, SUM-4 or LR03 type alkaline batteries.
- Replace two batteries at the same time.
- Do not use a new battery with a used battery.
- Avoid contact with water or liquid.
- Do not expose the remote control unit to moisture or heat.
- Do not drop the remote control unit.
- If the battery has leaked on the remote control unit, carefully wipe the case clean and install new batteries.
- Risk of explosion if battery is replaced by an incorrect type.
- Dispose of used batteries according to the instructions.

# Installation

## Positioning the Projector

This projector is designed to project on a flat projection surface and can be focused from 4.3'(1.3m) - 21.3'(6.5m). Refer to the figure and the table below for the screen size and the distance between the projector and the screen.

A : B = 9 : 1

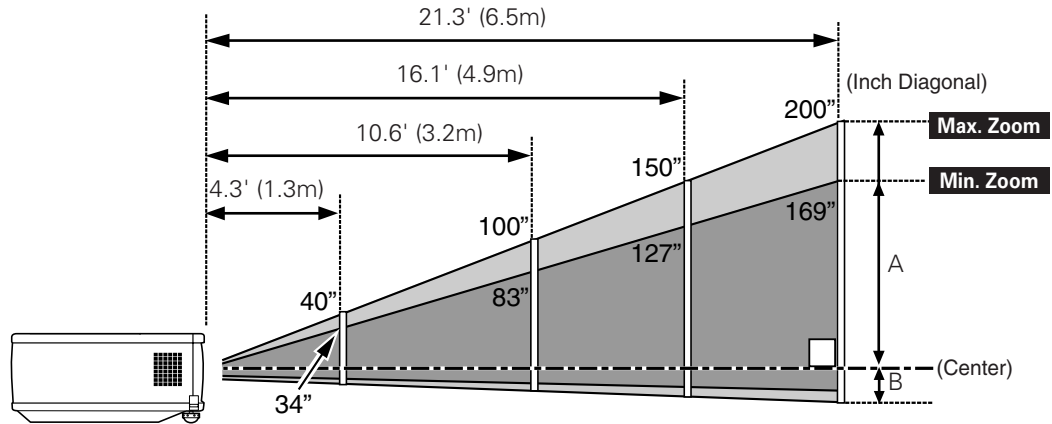

Screen Size (W x H) mm	34"	40"	100"	150"	200"
4 : 3 aspect ratio	691 x 518	813 x 610	2032 x 1524	3048 x 2286	4064 x 3048
Zoom (min)	4.3' (1.3m)	4.9' (1.5m)	12.5' (3.8m)	19.0' (5.8m)	—
Zoom (max)	—	4.3' (1.3m)	10.6' (3.2m)	16.1' (4.9m)	21.3' (6.5m)

### ✓ Note:

- The brightness in the room has a great influence on the picture quality. It is recommended to limit ambient lighting in order to obtain the best image.
- The values shown above are approximate and may vary from the actual size.

## Adjustable Feet

Projection angle can be adjusted up to 8.0 degrees with the adjustable feet.

- 1 Lift the front of the projector and pull upward the feet lock latches on both sides of the projector.
- 2 Release the feet lock latches to lock the adjustable feet and rotate the adjustable feet to adjust the position and tilt.
- 3 To retract the adjustable feet, lift the front of the projector and undo the feet lock latches. Keystone distortion of the projected image can be adjusted by the Menu operation. (p22, 38)

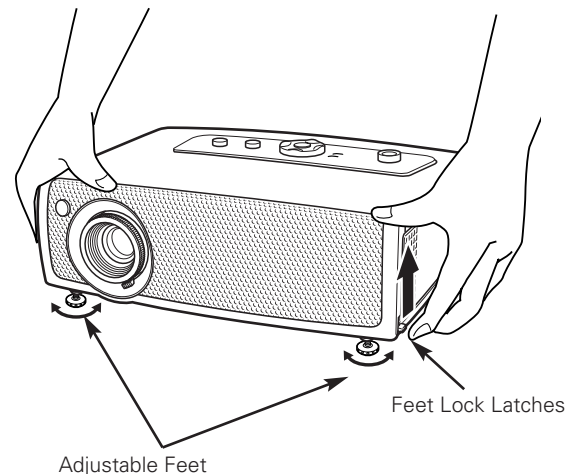

## Connecting the AC Power Cord

This projector uses nominal input voltages of 100-120 V or 200-240 V AC. This projector automatically selects the correct input voltage. It is designed to work with single-phase power systems having a grounded neutral conductor. To reduce risk of electrical shock, do not plug into any other type of power system.

Consult your authorized dealer or service station if you are not sure of the type of power being supplied.

Connect the projector with all peripheral equipment before turning the projector on. (See page 15, 16 for connection.)



### CAUTION

For safety, unplug the AC power cord when the projector is not in use. When this projector is connected to an outlet with the AC power cord, it is in Stand-by mode and consumes a little electric power.

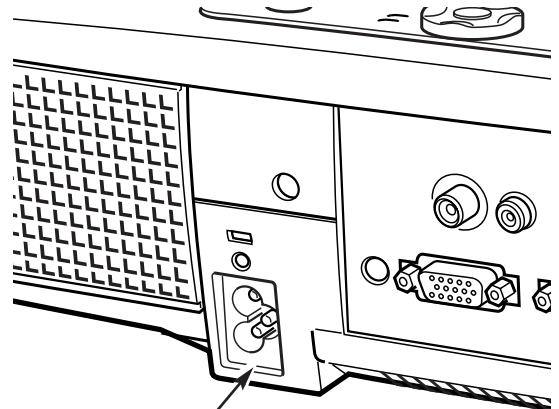

Connect the AC power cord (supplied) to the projector.

The AC outlet must be near this equipment and must be easily accessible.

### NOTE ON THE POWER CORD

AC power cord must meet requirement of the country where you use the projector. Confirm the AC plug type with the chart below and proper AC power cord must be used. If supplied AC power cord does not match your AC outlet, contact your sales dealer.

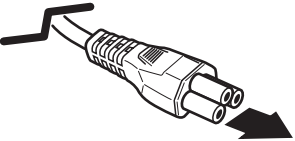
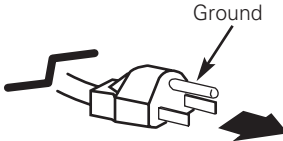
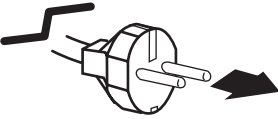
Projector side	AC outlet side	
 <p data-bbox="321 1339 602 1388">To the power cord connector on your projector.</p>	<p data-bbox="662 1136 932 1163"><b>For the U.S.A. and Canada</b></p>  <p data-bbox="834 1186 906 1213">Ground</p> <p data-bbox="776 1346 938 1394">To the AC outlet. <b>(120 V AC)</b></p>	<p data-bbox="992 1136 1261 1163"><b>For Continental Europe</b></p>  <p data-bbox="1094 1360 1279 1409">To the AC outlet. <b>(200 - 240 V AC)</b></p>

## Connecting to a Computer

### Cables used for connection

- VGA Cable (HDB 15 pin) (Only one cable is supplied)
  - Audio Cable (Mini Plug: stereo) \*
- (\* = Not supplied with this projector.)

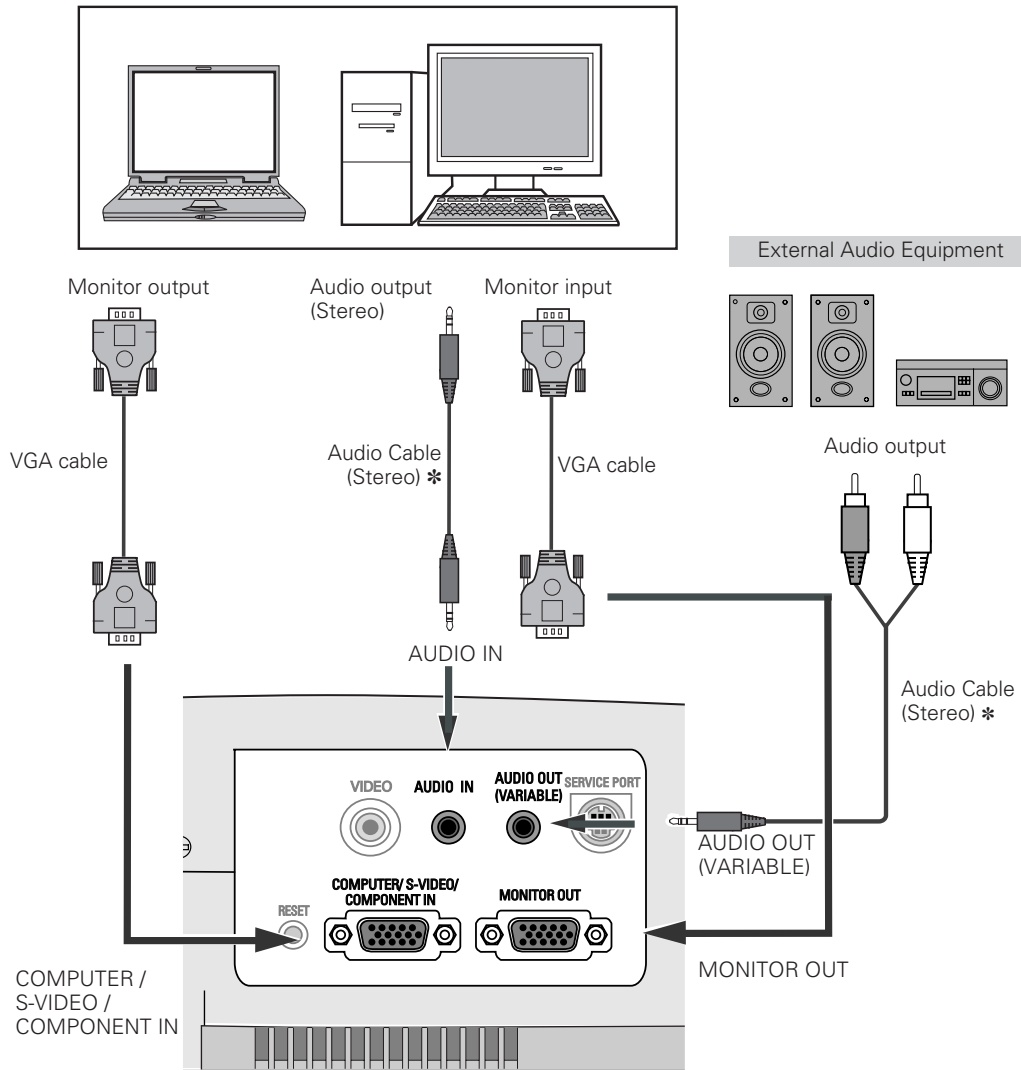

Installation

✓ **Note:**

- When connecting AUDIO OUT to external audio equipment, the projector's built-in speaker is disconnected.
- Audio out and Monitor out terminal works only when the projector is under operation and do not work when the projector is in the stand-by state or the Power management mode (p41).
- See p57 for ordering optional parts.



**Note:**

When connecting the cable, the power cords of both the projector and the external equipment should be disconnected from AC outlet.

## Connecting to Video Equipment

### Cables used for connection

- Scart-VGA Cable (Separately supplied as LV-CA31) \*
  - S-VIDEO-VGA Cable (Separately supplied as LV-CA33) \*
  - S-VIDEO Cable \*
  - Component-VGA Cable (Separately supplied as LV-CA32) \*
  - Component Cable \*
  - Video Cable \*
  - Audio Cables (Mini Plug: stereo) \*
- (\* = Not supplied with this projector.)

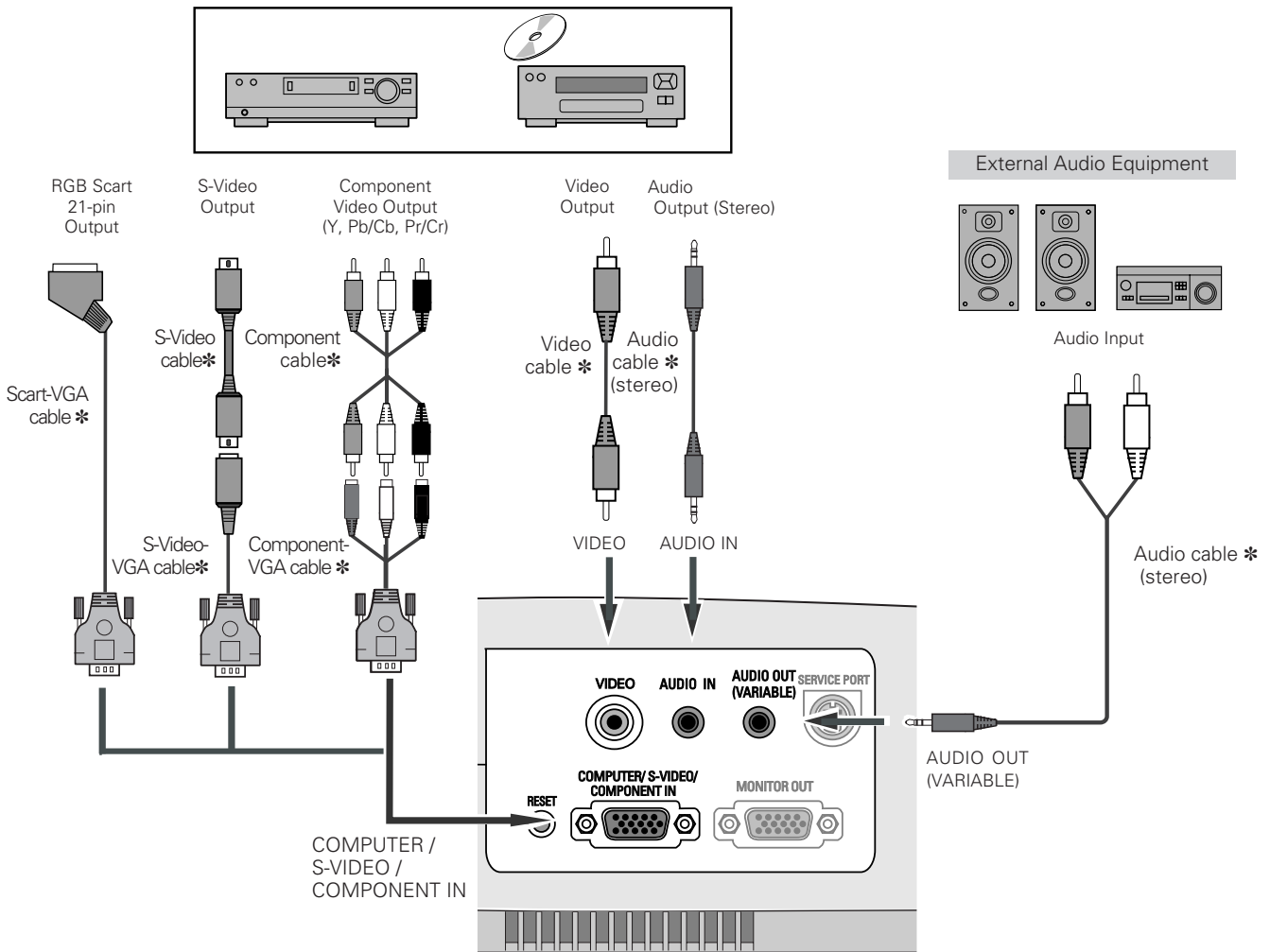

✓ **Note:**

- When connecting AUDIO OUT to external audio equipment, the projector's built-in speaker is disconnected.
- Audio out and Monitor out terminal works only when the projector is under operation and do not work when the projector is in the stand-by state or the Power management mode (p41).
- See p57 for ordering optional parts.



**Note:**

When connecting the cable, the power cords of both the projector and the external equipment should be disconnected from AC outlet.



## Turning On the Projector

- 1 Complete peripheral connections (with a computer, VCR, etc.) before turning on the projector.
- 2 Connect the projector's AC power cord into the AC outlet. The POWER indicator blinks red in a moment and emits red light.
- 3 Press the POWER button on the top control or on the remote control unit. The POWER indicator turns green lighting and the cooling fans start to operate. The preparation display appears on the screen and the count down starts.
- 4 After the count-down, the image level that was selected last and the Lamp mode status icon (see page 41) appear on the screen.

### ✓ Note:

- If the projector is locked with a PIN code, the PIN code Input Dialog Box will appear. Enter the PIN code as instructed below.
- When the On start function is on, this projector is turned on automatically by connecting the AC power cord to an AC outlet. (See page 41 for the On start function.)

### Enter a PIN code

Select a number by pressing the Point ◀▶ buttons and fix the number with the OK button. The number will change to "\*". If you fixed an incorrect number, move the pointer to "Set" or "Clear" once by pressing the Point ▼ button, then return to "PIN code". Enter the correct number again. Repeat this step to complete entering a four-digit number.

When the four-digit number is fixed, the pointer will automatically move to "Set". Press the OK button so that you can start to operate the projector.

If you entered an incorrect PIN code, "PIN code" and the number (\*\*\*\*) will turn red and disappear. Enter a correct PIN code all over again.

### What is PIN code?

PIN code is a security code using Personal Identification Number that allows the person who knows it to operate the projector. Setting the PIN code prevents others except the specific users from operating the projector.

A PIN code consists of a four-digit number. Refer to the PIN code lock function in Setting on page 43 for locking operation of the projector with your PIN code.

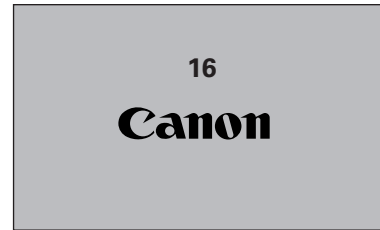

The preparation display disappears after 30 seconds.

### Selected Image Level and Lamp Mode

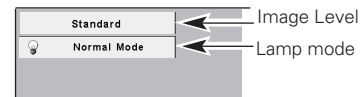

(See page 41 for Lamp mode.)

### PIN code Input Dialog Box

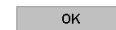

After the OK icon disappears, you can operate the projector.

### Turning Off the Projector

- 1** Press the POWER button on the top control or on the remote control unit, and a message "Power off?" appears on the screen.
- 2** Press the POWER button again to turn off the projector. The POWER indicator starts to blink red, and it continues while the cooling fans are operating for about 90 seconds. (About 120 seconds when the fan mode is L2. See page 44.)
- 3** When the projector has cooled down enough to be turned on again, the POWER indicator emits red light. Then you can disconnect the AC power cord.

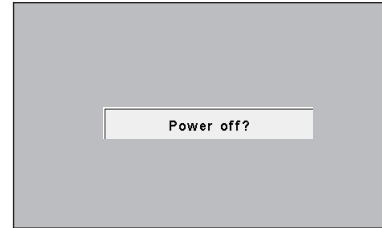

The message disappears after 4 seconds.



TO MAINTAIN THE LIFE OF THE LAMP, ONCE YOU TURN PROJECTOR ON, WAIT AT LEAST 5 MINUTES BEFORE TURNING IT OFF. DO NOT DISCONNECT AC POWER CORD WHILE COOLING FANS ARE RUNNING OR BEFORE THE POWER INDICATOR EMITS RED LIGHT. OTHERWISE IT WILL RESULT IN SHORTENING THE LAMP LIFE.

**✓ Note:**

- The projector cannot be turned on during the cooling period with the POWER indicator blinking red. You can turn it on again after the POWER indicator emits red light.
- Do not operate the projector continuously without rest. Continuous use may result in shortening the lamp life. Turn off the projector and give it a rest about an hour in every 24 hours.
- This projector monitors internal temperature and automatically controls the running speed of the cooling fans.
- If the WARNING indicator blinks or emits red light, see "Warning Indicator" on page 45.

## Zoom and Focus Adjustment

Rotate the Zoom Lever to zoom in and out.  
Rotate the Focus Ring to adjust the projected picture focus.

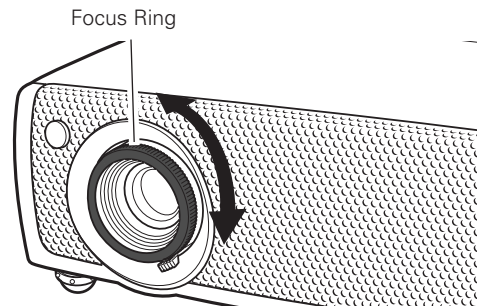
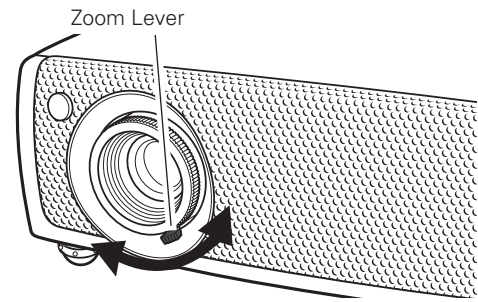

## How to Operate the On-Screen Menu

The projector can be adjusted or set via the On-Screen Menu. Refer to the following pages regarding each adjustment and setting procedure.

- 1 Press the MENU button to display the On-Screen Menu.
- 2 Press the Point  $\leftarrow$  buttons to select a Menu icon to adjust. Press the Point  $\uparrow$  buttons to select an item to adjust.
- 3 Press the OK button to show the item data. Press the Point  $\leftarrow$  buttons to adjust the data. Refer to the following pages for respective adjustment.

**✓ Note:**

- The selected item is not active until the OK button is pressed.

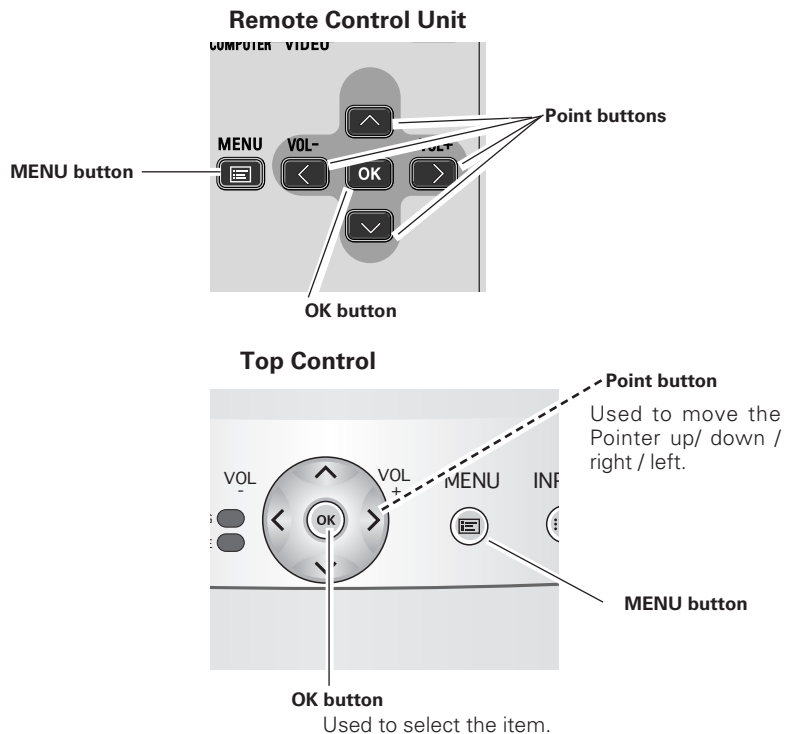
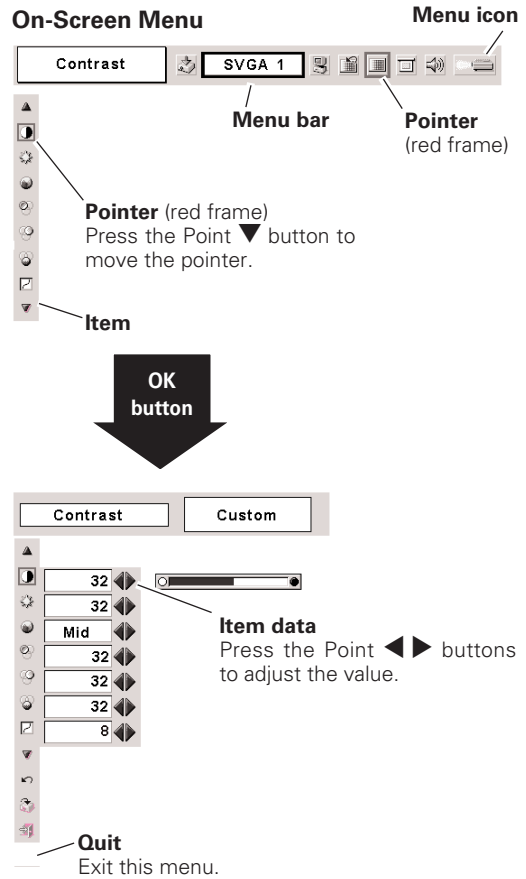

## Menu Bar

### For computer source

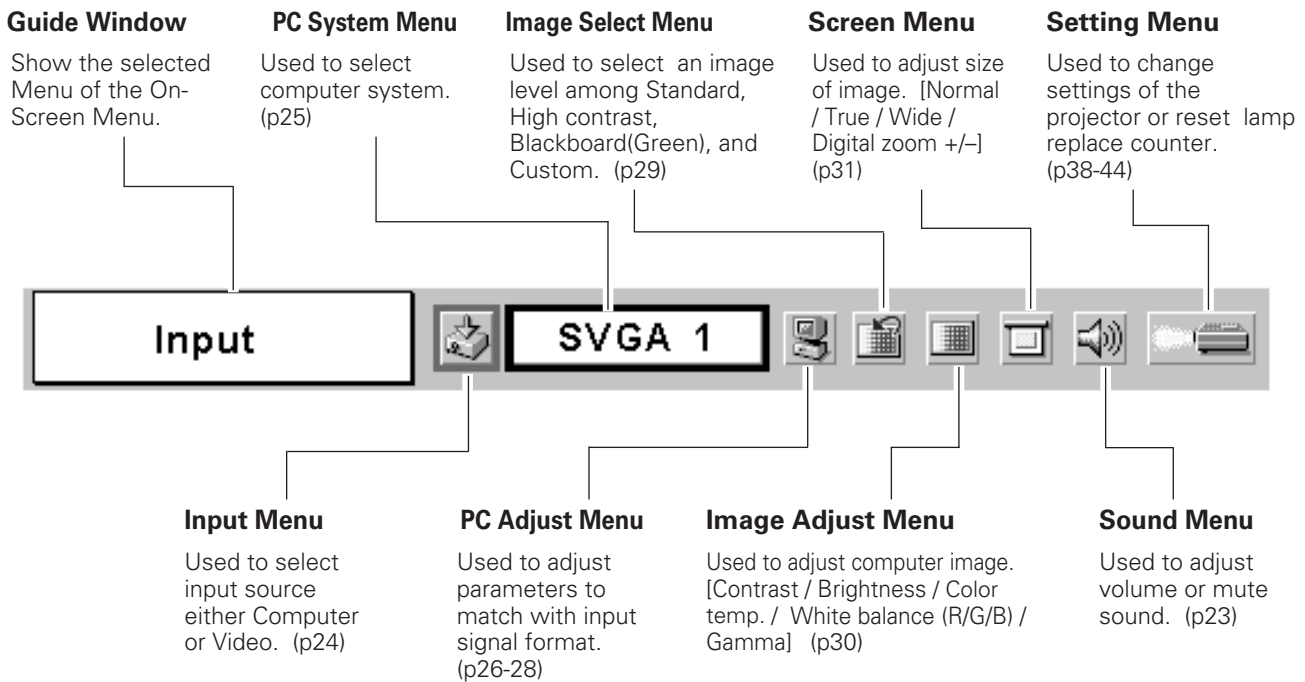

### For video source

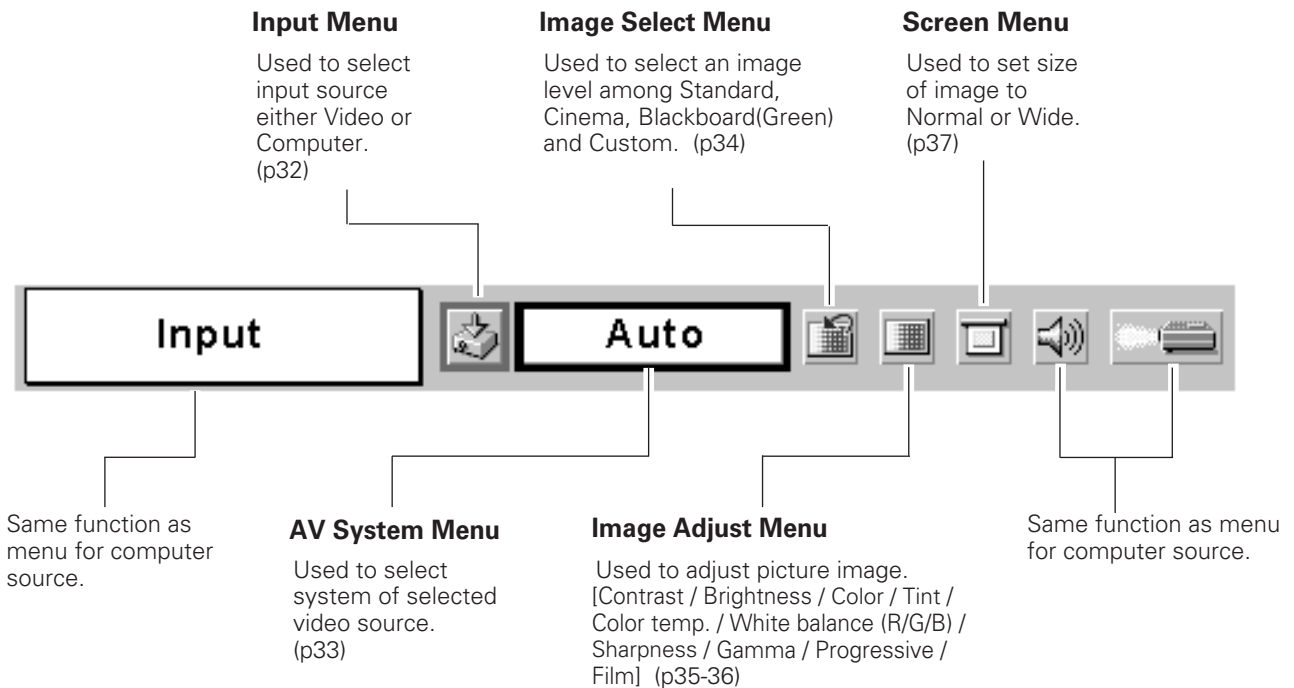

## Keystone Adjustment

If a projected picture has keystone distortion, correct the image with the keystone adjustment.

- 1 Press KEYSTONE button on the remote control unit or select Keystone on the Setting menu (p38) to display the Keystone dialog box.
- 2 Correct keystone distortion by pressing Point ▲▼ buttons. Press Point ▲ button to reduce the upper part of image, and press Point ▼ button to reduce the lower part.



- Arrows are blue in no correction.
- The arrow of direction being corrected turns light blue.
- The arrow disappears at the maximum correction.
- If you press the KEYSTONE on the remote control unit once more while the keystone dialog box is being displayed, the adjustment will be canceled.

Reduce the upper width with Point ▲ button.

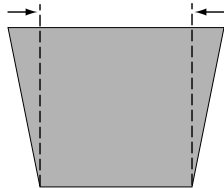

Reduce the lower width with Point ▼ button.

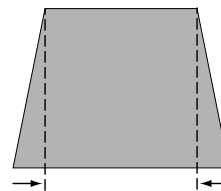

## Picture Freeze Function

Press the FREEZE button on the remote control unit to freeze the picture on the screen. To cancel freezing, press the FREEZE button again.

### Remote Control Unit

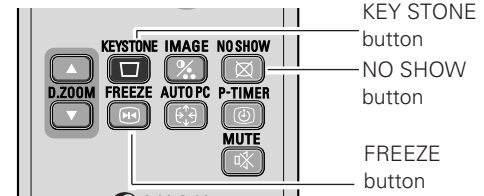

## No Show Function

Press the NO SHOW button on the remote control unit to black out the image. To restore to normal, press the NO SHOW button again or press any other button. When a projected image is captured and set as "User" in the Logo item in the Setting Menu (p40), the screen changes each time you press the NO SHOW button as follows.

black out → the captured image → normal → .....

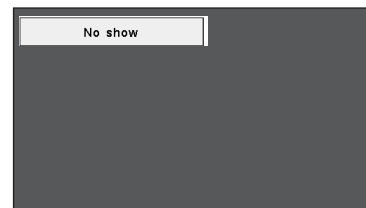

The message disappears after 4 seconds.

## P-Timer Function

Press the P-TIMER button on the remote control unit. The timer display "00 : 00" appears on the screen and the timer starts to count time (00 : 00 ~ 59 : 59).

To stop the P-Timer, press the P-TIMER button. Press the P-TIMER button again to cancel the P-Timer function.



Remote Control Unit

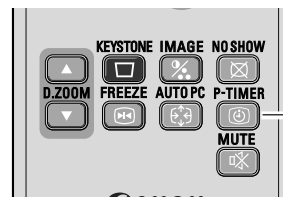

P-TIMER button

## Sound Adjustment

### Direct Operation

#### Volume

Press the VOL +/- buttons on the top control or on the remote control unit to adjust volume. The volume dialog box appears on the screen for a few seconds.

+ button to turn up the volume and - button to turn down the volume.

#### Mute

Press the MUTE button on the remote control unit to cut off the sound. To restore sound to its previous level, press the MUTE button again or press the VOL +/- buttons.

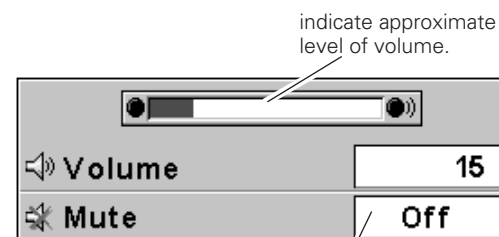

Press the MUTE button to set the Mute function On or Off.

The display disappears after 4 seconds.

### Menu Operation

**1** Press the MENU button and the On-Screen Menu will appear. Press the Point ◀▶ buttons to move the red frame pointer to the Sound Menu icon.

**2** Press the Point ▼ button to move the red frame pointer to the item that you want to select, and then press the OK button.

#### Volume

Press the Point ▶ button to turn up the volume, and press the Point ◀ button to turn down the volume.

#### Mute

Press the Point ◀▶ buttons to cut off the sound. Dialog box display is changed to "On" and the sound is cut off. To restore the sound to its previous level, press the Point ◀▶ buttons again.

Remote Control Unit



VOL - button

VOL + button

MUTE button

Sound Menu

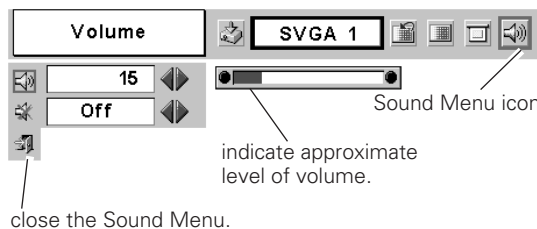

# Computer Input

## Input Source Selection

### Direct Operation

Select Computer by pressing the INPUT button on the top control or press the COMPUTER button on the remote control unit. Before using these buttons, correct input source should be selected through menu operation as described below.

### Top Control

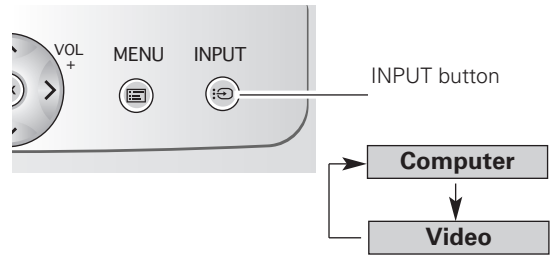

### Remote Control Unit

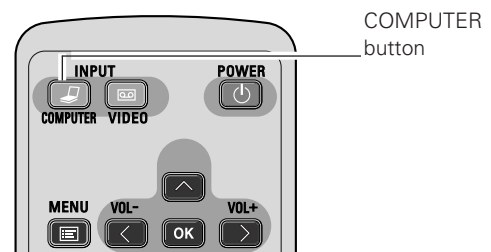

### Menu Operation

- 1 Press the MENU button and the On-Screen Menu will appear. Press the Point ◀▶ buttons to move the red frame pointer to the Input Menu icon.
- 2 Press the Point ▲▼ button to move the red arrow pointer to Computer and then press the OK button.
- 3 After the Source Select Menu appears for Computer, move the pointer to RGB and then press the OK button.

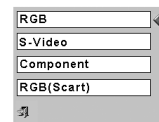
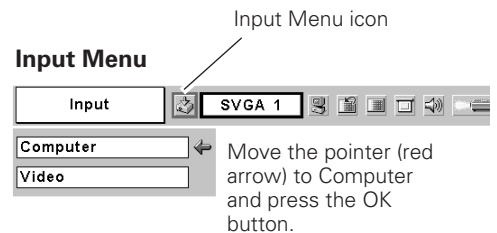

### Source Select Menu

Move the pointer to RGB and press the OK button.



## Computer System Selection

This projector automatically tunes to various types of computers based on VGA, SVGA, XGA or SXGA with its Multi-scan system and Auto PC Adjustment. If Computer is selected as a signal source, this projector automatically detects the signal format and tunes to project a proper image without any additional settings. (Signal formats provided in this projector is shown on page 55)

**✓ Note:**

- The projector may display one of the following messages.

**Auto** When the projector cannot recognize connected signal conforming to PC Systems provided in this projector, the Auto PC Adj. function works to display proper images and the message "Auto" is displayed on the PC System Menu icon. When the image is not projected properly, manual adjustment is required. (p27, 28)

**-----** There is no signal input from computer. Check the connection of your computer and the projector. (See "Troubleshooting" p50)

**Mode 1** User preset system manually adjusted in PC Adjustment menu. Adjusted data can be stored in Mode 1 - 5. (p27, 28)

**SVGA 1** PC system provided in the projector. The projector selects a proper system and displays it.

\*Mode 1 and SVGA 1 are examples.

### PC System Menu

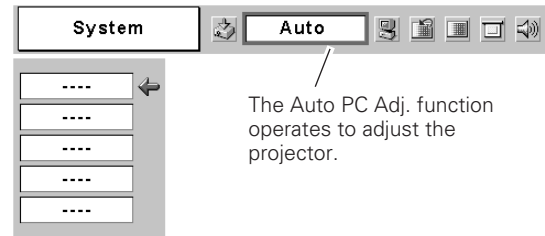

### Selecting Computer System Manually

PC system can also be selected manually.

- 1 Press the MENU button and the On-Screen Menu will appear. Press the Point ◀▶ buttons to move the red frame pointer to the PC System Menu icon.
- 2 Press the Point ▼ button to move the red arrow pointer to the system that you want to set, and then press the OK button.

### PC System Menu

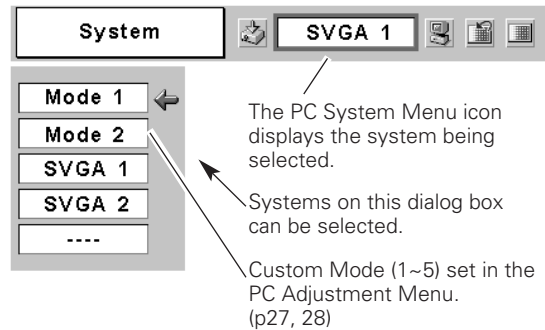

## Auto PC Adjustment

The Auto PC Adj. function is provided to automatically adjust Fine sync, Total dots, Horizontal, and Vertical to conform to your computer. The Auto PC Adj. function can be operated as follows.

### Direct Operation

The Auto PC adjustment function can be operated directly by pressing the AUTO PC button on the remote control unit.

### Remote Control Unit

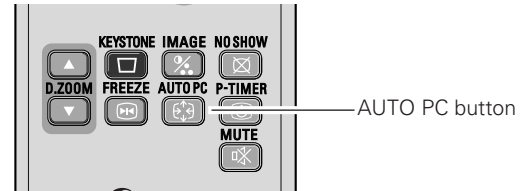

### Menu Operation

#### Auto PC Adj.

- 1 Press the MENU button to display the On-Screen Menu. Press the Point ◀▶ buttons to move the red frame pointer to PC Adjustment Menu icon.
- 2 Press the Point ▼ button to move the red frame pointer to Auto PC Adj. icon and then press the OK button twice.

### PC Adjust Menu

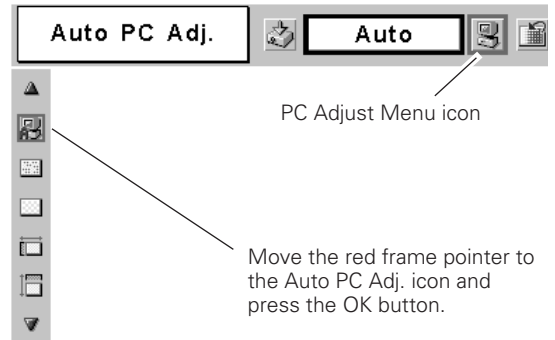

"Wait a moment!" message appears while Auto PC adjustment is in process.

### To store adjustment parameters

Adjustment parameters from Auto PC Adj. can be memorized in this projector. Once parameters are memorized, the setting can be done just by selecting Mode in the Computer System Menu (p25). See "Store" on page 28.

#### ✓ Note:

- Fine sync, Total dots and Picture Position of some computers can not be fully adjusted with this Auto PC Adj. function. When the image is not provided properly with this operation, manual adjustments are required. (p27, 28)
- The Auto PC Adj. cannot be operated when 480i, 575i, 480p, 575p, 720p, 1035i, or 1080i is selected in the Computer System Selection. (p25)

## Manual PC Adjustment

Some computers employ special signal formats which may not be tuned by Multi-scan system of this projector. Manual PC Adjustment enables you to precisely adjust several parameters to match those signal formats. The projector has 5 independent memory areas to memorize those parameters manually adjusted. It allows you to recall the setting for a specific computer.

- 1 Press the MENU button and the On-Screen Menu will appear. Press the Point ◀▶ buttons to move the red frame pointer to the PC Adjust Menu icon.
- 2 Press the Point ▼ button to move the red frame pointer to the item that you want to adjust and then press the OK button. An adjustment dialog box will appear. Press the Point ◀▶ buttons to adjust the value.

### **Fine sync**

Eliminate flicker from the displayed image. Press the Point ◀▶ buttons to adjust value. (From 0 to 31)

### **Total dots**

Adjust the number of total dots in one horizontal period. Press the Point ◀▶ buttons and adjust number to match your PC image.

### **Horizontal**

Adjust horizontal picture position. Press the Point ◀▶ buttons to adjust the position.

### **Vertical**

Adjust vertical picture position. Press the Point ◀▶ buttons to adjust the position.

### **Current mode**

Press the OK button to show H-Freq. and V-Freq. of the connected computer.

### **Clamp**

Adjust clamp level. When the image has dark bars, try this adjustment.

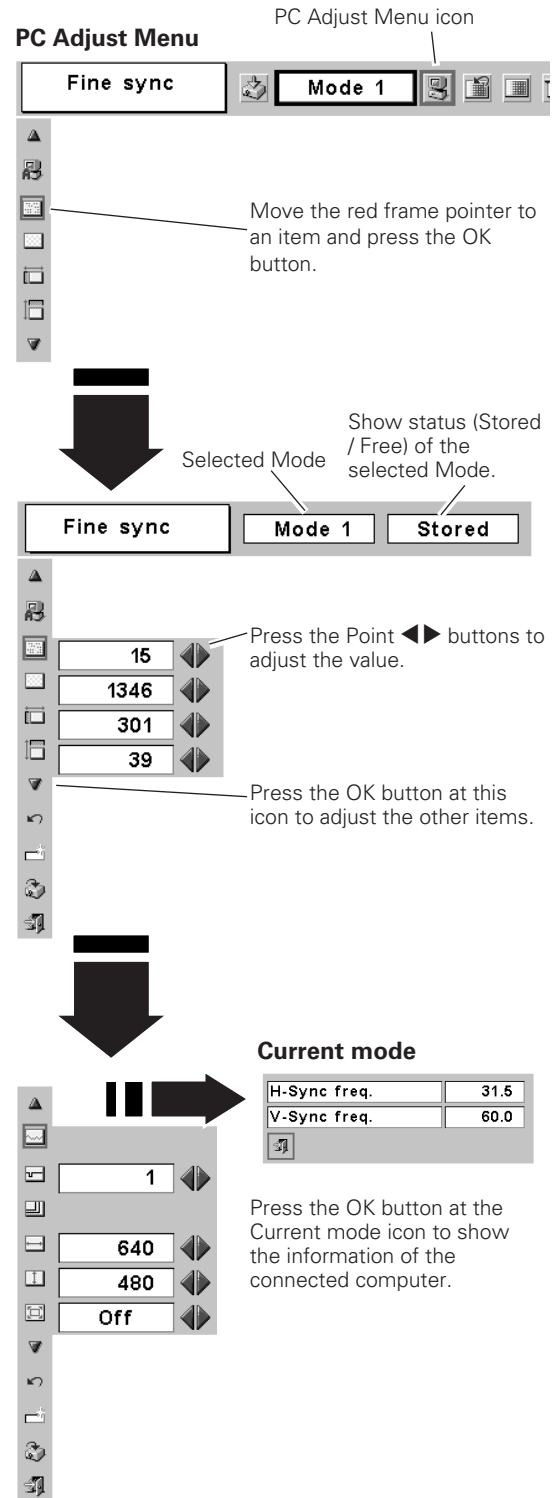

**PC Adjust Menu**

PC Adjust Menu icon

Move the red frame pointer to an item and press the OK button.

Show status (Stored / Free) of the selected Mode.

Selected Mode

Press the Point ◀▶ buttons to adjust the value.

Press the OK button at this icon to adjust the other items.

**Current mode**

H-Sync freq.	31.5
V-Sync freq.	60.0

Press the OK button at the Current mode icon to show the information of the connected computer.

 **Display area**

Press the OK button to display the Display area dialog box. Select the resolution at the Display area dialog box.

 **Display area H**

Adjust the horizontal area displayed by this projector. Press the Point  $\blacktriangleleft\blacktriangleright$  buttons to decrease/increase the value and then press the OK button.

 **Display area V**

Adjust the vertical area displayed by this projector. Press the Point  $\blacktriangleleft\blacktriangleright$  buttons to decrease/increase the value and then press the OK button.

 **Full screen**

With this function on, SXGA image is fully displayed at 4 : 3 aspect ratio. It is displayed at 5 : 4 aspect ratio with this function off.

 **Reset**

To reset the adjusted data, select Reset and press the OK button. The confirmation box will appear and then select [Yes]. All adjustments return to their previous figures.

 **Mode free**

To clear adjusted data previously set, move the red frame pointer to the Mode free icon and then press the OK button. Move the red arrow pointer to the Mode that you want to clear and then press the OK button.

 **Store**

To store adjusted data, move the red frame pointer to the Store icon and then press the OK button. Move the red arrow pointer to any of Mode 1 to 5 in which you want to store and then press the OK button.

 **Quit**

Exit the PC Adjustment Menu.

 **Note:**

- Auto PC Adj., Display area, Display area (H/V), and Full screen cannot be selected when "480i", "575i", "480p", "575p", "720p", "1035i", or "1080i" is selected in the Computer System Menu (p25).

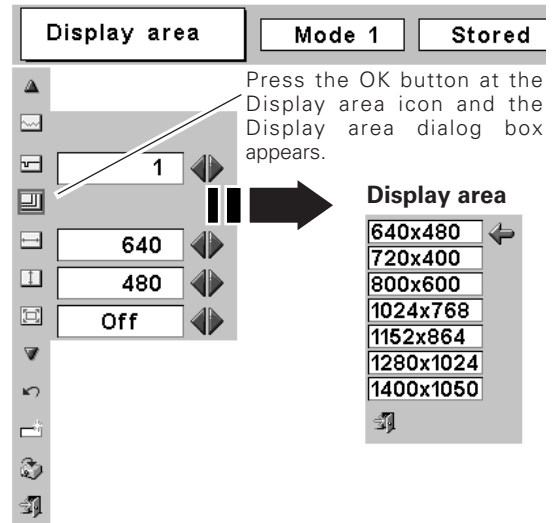

**To store adjusted data**

This Mode has parameters being stored.

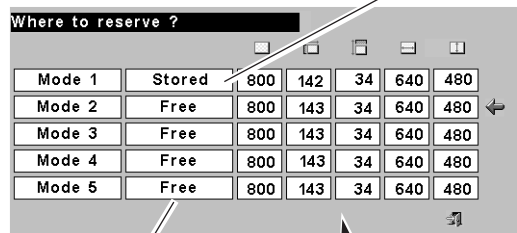

Vacant Mode

Show values of "Total dots," "Horizontal," "Vertical," "Display area H," and "Display area V."

**To clear adjusted data**

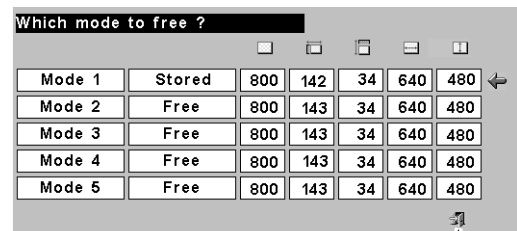

Close this dialog box.

## Image Level Selection

### Direct Operation

Select an image level among Standard, High contrast, Blackboard(Green), Custom by pressing the IMAGE button on the remote control unit.

#### Standard

Normal picture level preset on this projector.

#### High Contrast

Picture adjustment improved in reproduction of the halftones. This adjustment is suitable for providing a better image in a brighter place.

#### Blackboard(Green)

Picture level suitable for the image projected on a blackboard. This mode assists to enhance the image projected on a blackboard. This is mainly effective on a green colored board, not truly effective on a black colored board.

#### Custom

User preset image in the Image Level Adjustment (p30).

### Remote Control Unit

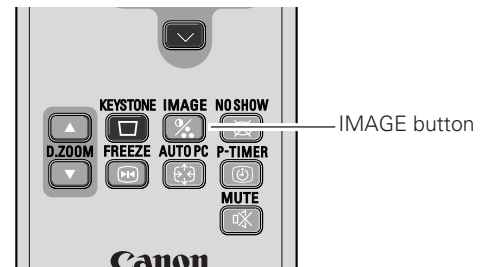

### IMAGE button

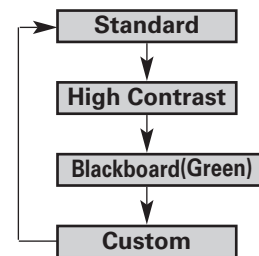

### Menu Operation

- 1 Press the MENU button and the On-Screen Menu will appear. Press the Point ◀▶ buttons to move the red frame pointer to the Image Select Menu icon.
- 2 Press the Point ▼ button to move the red frame pointer to the level that you want to set and then press the OK button.



#### Standard

Normal picture level preset on this projector.



#### High contrast

Picture adjustment improved in reproduction of the halftones. This adjustment is suitable for providing a better image in a brighter place.



#### Blackboard(Green)

Picture level suitable for the image projected on a blackboard. See above for further description.



#### Custom

User preset image in the Image Level Adjustment (p30).

### Image Select Menu

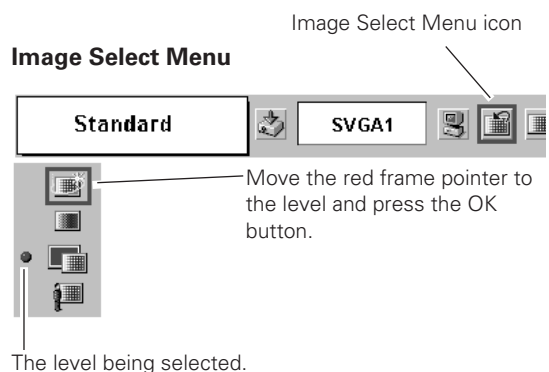

## Image Level Adjustment

- 1 Press the MENU button and the On-Screen Menu will appear. Press the Point ◀▶ buttons to move the red frame pointer to the Image Adjust Menu icon.
- 2 Press the Point ▼ button to move the red frame pointer to the item that you want to adjust, and then press the OK button. The level of each item is displayed. Adjust each level by pressing the Point ◀▶ buttons.



### Contrast

Press the Point ◀ button to decrease contrast and the Point ▶ button to increase contrast. (From 0 to 63.)



### Brightness

Press the Point ◀ button to adjust image darker and the Point ▶ button to adjust image brighter. (From 0 to 63.)



### Color temp.

Press the Point ◀ button or the Point ▶ button for Color temp. level that you want to select. (XLow, Low, Mid, or High)



### White balance (Red)

Press the Point ◀ button to lighten red tone and the Point ▶ button to deepen red tone. (From 0 to 63.)



### White balance (Green)

Press the Point ◀ button to lighten green tone and the Point ▶ button to deepen green tone. (From 0 to 63.)



### White balance (Blue)

Press the Point ◀ button to lighten blue tone and the Point ▶ button to deepen blue tone. (From 0 to 63.)



### Gamma

Press the Point ◀▶ buttons to obtain better balance of contrast. (From 0 to 15.)



### Reset

To reset the adjusted data, select Reset and press the OK button. The confirmation box will appear and then select [Yes]. All adjustments return to their previous figures.



### Store

To store the image data adjusted manually, move the red frame pointer to the Store icon and press the OK button. The message "OK?" will appear. Select [Yes] to store manual adjustment. To set this manual adjustment, select Custom by pressing the IMAGE button or through the Image Select Menu (p29).

If you change the Image level (p29) without storing the adjusted data, the figures will go back to the factory default settings.



### Quit

Close the Image Level Adjustment.

#### ✓ Note:

- After adjusting any of the White balance Red, Green or Blue, the Color temp. will change to "Adj."

### Image Adjust Menu

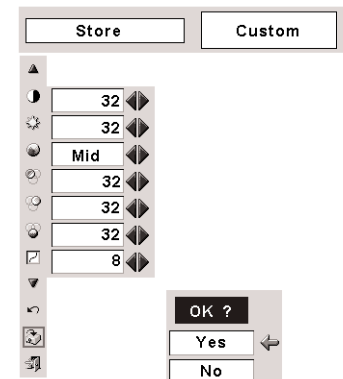
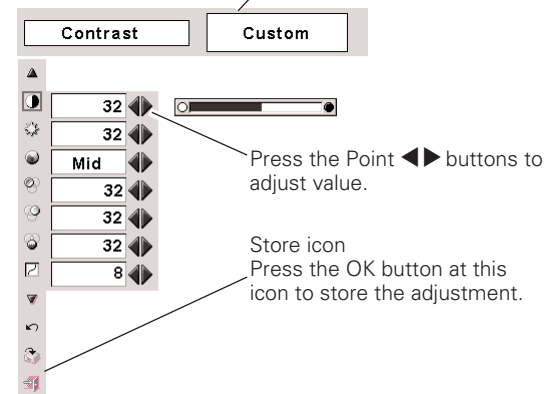
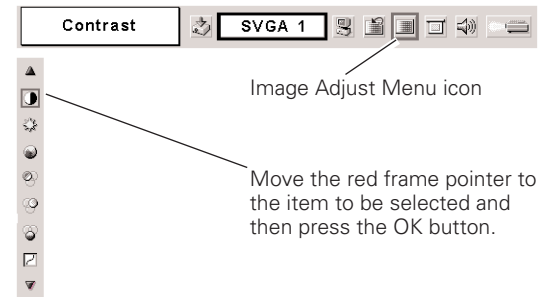

"OK?" message  
Move the pointer to [Yes] and then press the OK button.

## Screen Size Adjustment

This projector has a picture screen resize function, which allows you to customize the image size.

- 1 Press the MENU button and the On-Screen Menu will appear. Press the Point ◀▶ buttons to move the red frame pointer to the Screen Menu icon.
- 2 Press the Point ▼ button and move the red frame pointer to the function that you want to select and then press the OK button.

### Normal

Provide image to fit screen size.

### True

Provide image in its original size. When the original image size is larger than the screen size (800 x 600), this projector enters "Digital zoom +" mode automatically.

### Wide

Provide image to fit wide video aspect ratio (16 : 9) by expanding image width uniformly. This function can be used for providing a squeezed video signal at 16 : 9.

### Digital Zoom +

When the Digital Zoom + is selected, the On-Screen Menu disappears and the message "D. Zoom +" is displayed. Press the OK button to expand the image size. And press the Point ▲▼◀▶ buttons to pan the image. The Panning function can work only when the image is larger than the screen size.

A projected image can be also expanded by pressing the D.ZOOM ▲ button on the remote control unit.

### Digital Zoom -

When the Digital Zoom - is selected, the On-Screen Menu disappears and the message "D. Zoom -" is displayed. Press the OK button to compress the image size.

A projected image can be also compressed by pressing the D.ZOOM ▼ button on the remote control unit.

To exit the Digital Zoom +/- mode, press any button except the D.ZOOM ▲▼, OK, and Point button.

To return to the previous screen before adjusting the screen size, select Screen size from the Screen Size Adjustment or Input source from the Input Source Selection (p24) again, or adjust the screen size with the D.ZOOM or the OK button.

#### ✓ Note:

- This Screen Menu cannot be operated when "720p(HDTV)", "1035i (HDTV)", or "1080i (HDTV)" is selected in the Computer System Menu (p25).
- The True and Digital Zoom +/- cannot be selected when "480i", "575i", "480p", or "575p" is selected in the Computer System Menu (p25).
- This projector cannot display any resolution higher than 1280 x 1024. If your computer's screen resolution is higher than 1280 X 1024, reset the resolution to the lower before connecting to the projector.
- The image data in other than SVGA (800 x 600) is modified to fit the screen size in initial mode.
- The panning function may not operate properly if the computer system prepared in the PC Adjustment Menu is used.

### Screen Menu

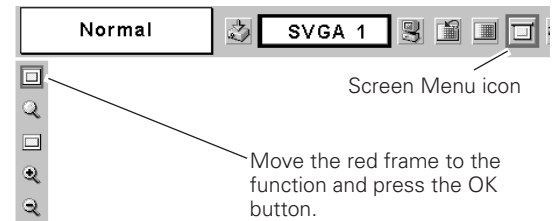

### Remote Control Unit

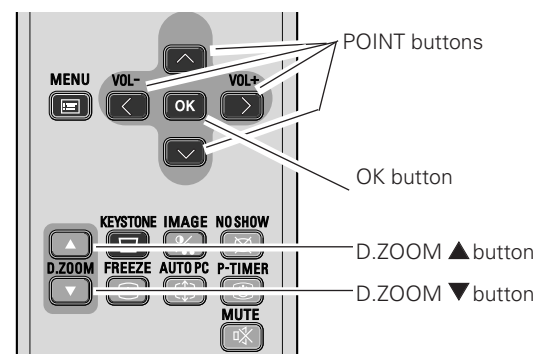

# Video Input

## Input Source Selection

### Direct Operation

Select either Video or Computer by pressing the INPUT button on the top control or VIDEO or COMPUTER button on the remote control unit.

Before using these buttons, correct input source should be selected through menu operation as described below.

### Top Control

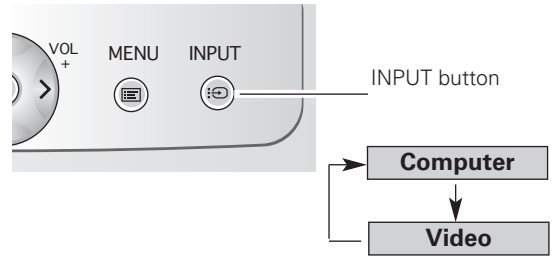

### Remote Control Unit

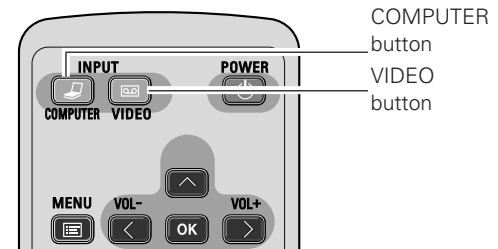

### Menu Operation

- 1 Press the MENU button and the On-Screen Menu will appear. Press the Point ◀▶ buttons to move the red frame pointer to the Input Menu icon.
- 2 Press the Point ▼ button to move the red arrow pointer to Video or Computer and then press the OK button. The Source Select Menu will appear. When you select Video, video input is selected. When you select Computer, move the pointer to the correct input source and then press the OK button.

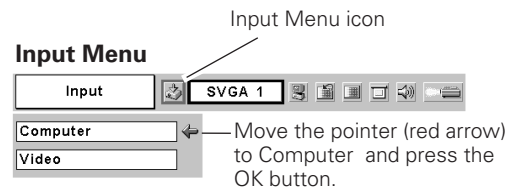

### Source Select Menu

Move the pointer to S-Video, Component or RGB (Scart) and press the OK button.

**S-Video** When the input source is connected to the COMPUTER / S-VIDEO / COMPONENT IN with a S-Video-VGA Cable, select S-Video.

**Component** When the input source is coming from video equipment connected to the COMPUTER / S-VIDEO / COMPONENT IN with a Component-VGA Cable, select Component.

**RGB (Scart)** When the input source is coming from video equipment connected to the COMPUTER / S-VIDEO / COMPONENT IN with a Scart-VGA Cable, select RGB (Scart).

#### ✓ Note:

- S-Video-VGA Cable, Component-VGA Cable and Scart-VGA Cable are optionally supplied. See page 57 for order.



## Video System Selection

- 1 Press the MENU button and the On-Screen Menu will appear. Press the Point ◀▶ buttons to move the red frame pointer to the AV System Menu icon.
- 2 Press the Point ▼ button to move the red arrow pointer to the system that you want to select and then press the OK button.

### Video or S-Video

#### Auto

The projector automatically detects incoming video system, and adjusts itself to optimize its performance. When Video System is PAL-M or PAL-N, select system manually.

#### **PAL / SECAM / NTSC / NTSC4.43 / PAL-M / PAL-N**

If the projector cannot reproduce proper video image, it is necessary to select a specific broadcast signal format among PAL, SECAM, NTSC, NTSC 4.43, PAL-M, and PAL-N.

#### AV System Menu (Video or S-Video)

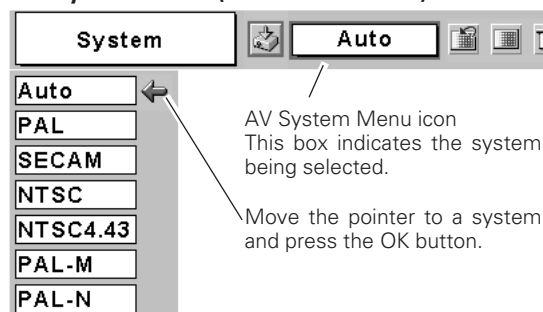

### Component

#### Auto

The projector automatically detects incoming video signal, and adjusts itself to optimize its performance.

#### **COMPONENT VIDEO SIGNAL FORMAT**

If the projector cannot reproduce proper video image, it is necessary to select a specific component video signal format among 480i, 575i, 480p, 575p, 720p, 1035i, and 1080i.

#### AV System Menu (Component)

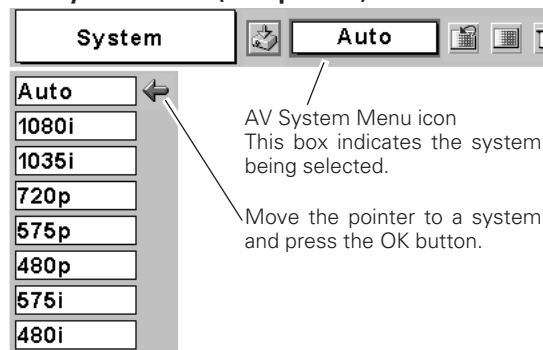

## Image Level Selection

### Direct Operation

Select a desired image level among Standard, Cinema, Blackboard (Green), Custom by pressing the IMAGE button on the remote control unit.

#### Standard

Normal picture level preset on this projector.

#### Cinema

Picture level adjusted for the picture with fine tone.

#### Blackboard(Green)

Picture level suitable for the image projected on a blackboard  
This mode assists to enhance the image projected on a blackboard. This is mainly effective on a green colored board, not truly effective on a black colored board.

#### Custom

User preset image in the Image Level Adjustment (p35, 36).

### Menu Operation

- 1 Press the MENU button and the On-Screen Menu will appear. Press the Point ◀▶ buttons to move the red frame pointer to the Image Select Menu icon.
- 2 Press the Point ▼ button to move the red frame pointer to the level that you want to set and then press the OK button.



#### Standard

Normal picture level preset on this projector.



#### Cinema

Picture level adjusted for the picture with fine tone.



#### Blackboard(Green)

Picture level suitable for the image projected on a blackboard. See above for further description.



#### Custom

User preset image in the Image Level Adjustment (p35, 36).

### Remote Control Unit

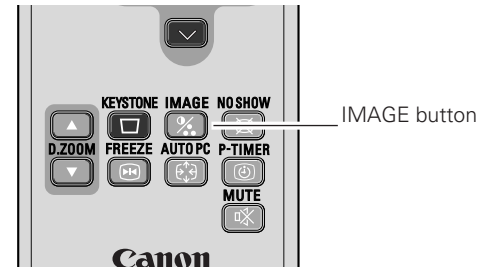

### IMAGE button

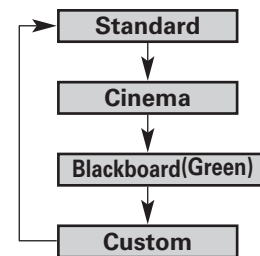

### Image Select Menu

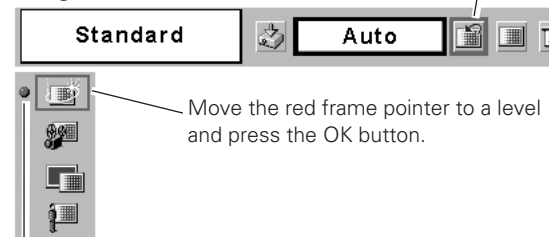

The level being selected.

## Image Level Adjustment

- 1 Press the MENU button and the On-Screen Menu will appear. Press the Point ◀▶ buttons to move the red frame pointer to the Image Adjust Menu icon.
- 2 Press the Point ▼ button to move the red frame pointer to the item that you want to adjust and then press the OK button. The level of each item is displayed. Adjust each level by pressing the Point ◀▶ buttons.

### Contrast

Press the Point ◀ button to decrease contrast and the Point ▶ button to increase contrast. (From 0 to 63.)



### Brightness

Press the Point ◀ button to adjust image darker and the Point ▶ button to adjust image brighter. (From 0 to 63.)



### Color

Press the Point ◀ button to lighten color and the Point ▶ button to deepen color. (From 0 to 63.)



### Tint

Press the Point ◀▶ buttons to obtain proper color. (From 0 to 63.)



### Color temp.

Press the Point ◀▶ buttons for Color temp. level that you want to select. (XLow, Low, Mid, or High)



### White balance (Red)

Press the Point ◀ button to lighten red tone and the Point ▶ button to deepen red tone. (From 0 to 63.)



### White balance (Green)

Press the Point ◀ button to lighten green tone and the Point ▶ button to deepen green tone. (From 0 to 63.)



### White balance (Blue)

Press the Point ◀ button to lighten blue tone and the Point ▶ button to deepen blue tone. (From 0 to 63.)



### Sharpness

Press the Point ◀ button to soften the image and the Point ▶ button to sharpen the image. (From 0 to 15.)



### Gamma

Press the Point ◀▶ buttons to obtain better balance of contrast. (From 0 to 15.)

#### ✓ Note:

- The Tint cannot be adjusted when the video system is PAL, SECAM, PAL-M, or PAL-N.
- After adjusting any of the White balance Red, Green or Blue, the Color temp. will change to "Adj."

### Image Adjust Menu

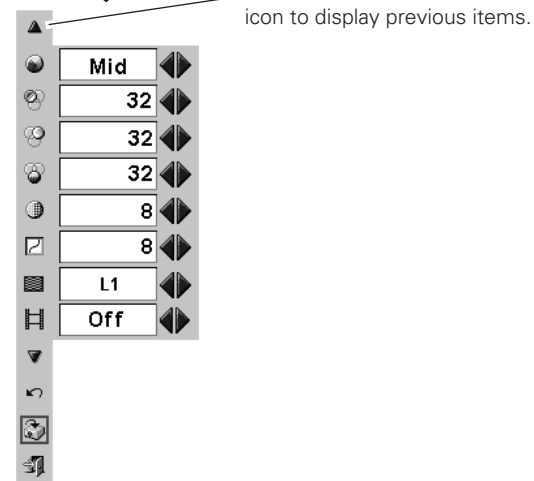
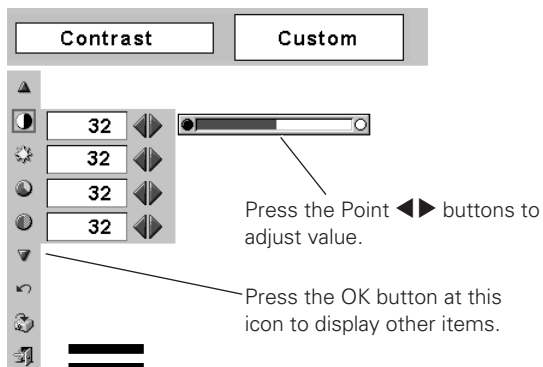
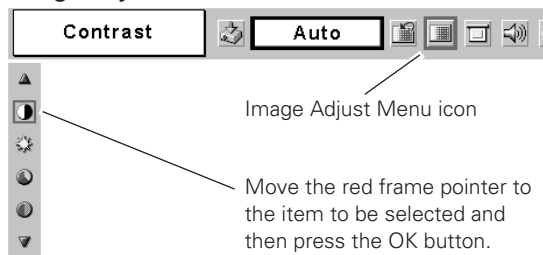

### Progressive

Interlaced video signal can be displayed in a progressive picture.

Off . . . .Not activated.

L1 . . . .Select "L1" for an active picture.

L2 . . . .Select "L2" for a still picture.

### Film

This function is effective on 3-2 pulldown video sources. With this function on, the projector reproduces pictures faithful to the original film quality.

### Reset

To reset the adjusted data, select Reset and press the OK button. The confirmation box will appear and then select [Yes]. All adjustments return to their previous figures.

### Store

To store the image data adjusted manually, move the red frame pointer to the Store icon and press the OK button. The message "OK?" will appear. Select [Yes] to store the manual adjustment.

To set this manual adjustment, select Custom by pressing the IMAGE button or through the Image Select Menu (p34).

If you change the Image level (p34) without storing the adjusted data, the figures will go back to the factory default settings.

### Quit

Close the Image Level Adjustment.

#### ✓ Note:

- Progressive cannot be selected when 480p, 575p, 720p, 1035i, or 1080i is selected. (p33)
- Film can only be activated when selecting NTSC for Video System and L1/ L2 for Progressive and in any state shown below.
  1. When selecting NTSC, NTSC4.43 PAL-M or 480i in the Video System Selection (p33).
  2. When selecting Auto and signal is NTSC, NTSC4.43, PAL-M(Composite) or 480i(Component) in the Video System Selection (p33).
- 3-2 Pulldown or Telecine transfer is the process of changing images from film mode to video mode. While film runs at 24 frames per second (fps), NTSC television signals (or video) have a run rate of 30fps so the 24 fps film needs to be speeded up to 30fps and transferred using a proper field pattern to get the best film-like images.

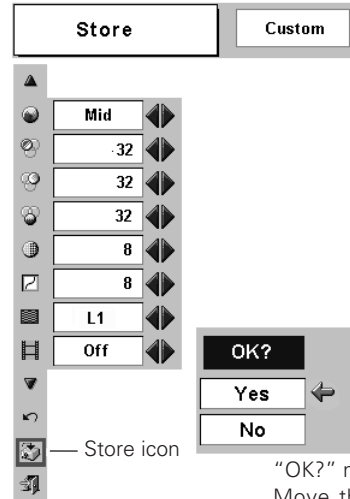

"OK?" message  
Move the pointer to [Yes]  
and then press the OK  
button.

## Screen Size Adjustment

This projector has a picture screen resize function, which allows you to customize the image size.

- 1 Press the MENU button and the On-Screen Menu will appear. Press the Point ◀▶ buttons to move the red frame pointer to the Screen Menu icon.
- 2 Press the Point ▼ button and move the red frame pointer to the function that you want to select and then press the OK button.

### **Normal**

Provide image at a normal video aspect ratio of 4 : 3.

### **Wide**

Provide image at a wide screen ratio of 16 : 9.

#### ✓ **Note:**

- Screen Menu cannot be operated when "720p", "1035i", or "1080i" is selected in the Video System Selection (p33).

### Screen Menu



## Setting

Setting menu allows you to set up the other various functions described as follows;

- 1 Press the MENU button to display the On-Screen Menu. Press the Point ◀▶ buttons to move the red frame pointer to the Setting Menu icon.
- 2 Press the Point ▼ button to move the red frame pointer to the item that you want to set and then press the OK button. The Setting dialog box appears.



### Language

The language used in the On-Screen Menu is available in English, German, French, Italian, Spanish, Portuguese, Dutch, Swedish, Russian, Chinese, Korean, or Japanese.



### Keystone

This function corrects distortion of the projected image. Select either Store or Reset with the Point ◀▶ buttons, and then press the OK button. The keystone dialog box appears. Adjust keystone with the Point ▲▼ buttons.

Store . . . . stores the keystone adjustment even after the AC power cord is disconnected.

Reset . . . . resets the keystone adjustment when the AC power cord is disconnected.



### Blue back

When this function is "On", the projector produces a blue image while input signal is not detected.



### Display

This function decides whether to display On-Screen Displays.

On . . . . . shows all the On-Screen Displays.

Off . . . . . does not show On-Screen Displays except;

- On-Screen Menu
- "Power off?" message
- P-Timer
- "No signal" message
- "Wait a moment!" message

### Setting Menu (Language)

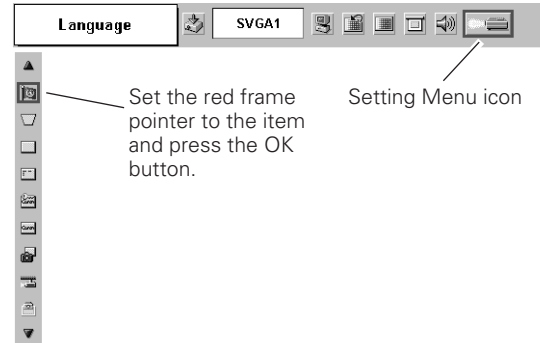

When pressing the OK button at Language, the Language Menu appears.

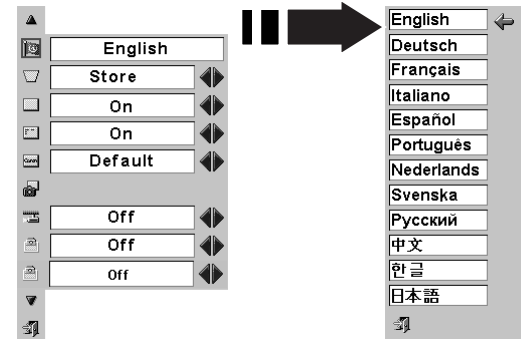

**Logo PIN code lock**

This function prevents an unauthorized person from changing the Logo setting.

- Off . . . . .the Logo setting can be changed freely from the Logo menu. (p40)
- On . . . . .the Logo setting cannot be changed without the Logo PIN code.

If you want to change the Logo PIN code lock setting, enter a Logo PIN code along the following steps. The initial Logo PIN code is set "4321" at the factory.

**Enter a Logo PIN code**

Select a number by pressing the Point ◀▶ buttons and fix the number with the OK button. The number will change to "\*". If you fixed an incorrect number, move the pointer to "Set" or "Clear" once by pressing the Point ▼ button, then return to "Logo PIN code". Enter the correct number again.

Repeat this step to complete entering a four-digit number.

When the four-digit number is fixed, the pointer will automatically move to "Set". Press the OK button so that you can change the Logo PIN code lock setting.

If you entered an incorrect Logo PIN code, "Logo PIN code" and the number (\*\*\*\*) will turn red and disappear. Enter a correct Logo PIN code all over again.

**Change the Logo PIN code**

Logo PIN code can be changed to your desired four-digit number. Select "Logo PIN code change" with the Point ▼ button and press the OK button. Set a new Logo PIN code.

Be sure to note the new Logo PIN code and keep it at hand.

**✓ Note:**

- If you forget your Logo PIN code and unable to change it, the Logo PIN code can be reset to the factory default setting (4321) according to the following procedures. When you reset the Logo PIN code, the PIN code and Key lock will be reset, as well.
  1. Disconnect the AC Power Cord from the AC outlet.
  2. As pressing the OK button on the projector, connect the AC Power Cord into an AC outlet again. Keep pressing the OK button until the POWER indicator emits. The Logo PIN code will be returned to the factory default setting while the Logo PIN code lock state will remain the same as previous set state.

**Logo PIN code lock**

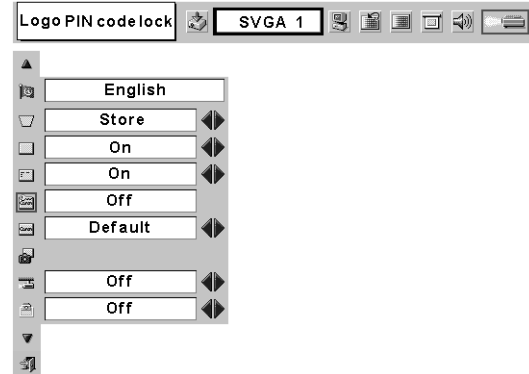

**Logo PIN code lock Dialog Box**

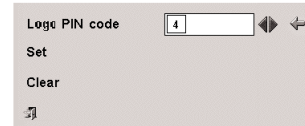

After a correct Logo PIN code is entered, the following dialog box will appear.



Select On/Off by pressing the Point ◀▶ buttons or change the Logo PIN code.

 **Logo**

This function decides what to be displayed on the starting-up display as follows:

- User . . . . .the image you captured
- Default . . . .the factory-set logo
- Off . . . . .count-down only

 **Capture**

This function enables you to capture the image being projected and use it for a starting-up display or interval of presentations.

After capturing the projected image, go to the Logo function and set it to "User". Then the captured image can be displayed when turning on the projector next time or pressing the NO SHOW button. (p22)

To capture the image, select [Yes]. To cancel the Capture function, select [No].

**✓ Note:**

- Before capturing an image, select Standard in the Image Select Menu to capture a proper image. (See page 29, 34.)
- A signal from a computer can be captured up to XGA(1024 x 768). A signal from video equipment can be captured except for 720p, 1035i, and 1080i.
- When capturing the image that has been adjusted by the Keystone function, the adjusted data is automatically reset and the projector captures an image without keystone adjustment.
- When the Logo PIN code lock function is On, the Logo and Capture menu cannot be selected.
- When starting to capture the new image, the previously stored image is cleared even if you cancel capturing.

 **Ceiling**

When this function is "On", the picture is top/bottom and left/right reversed. This function is used to project the image from a ceiling mounting the projector.

 **Rear**

When this function is "On", the picture is left/right reversed. This function is used to project the image to a rear projection screen.

**Capture**

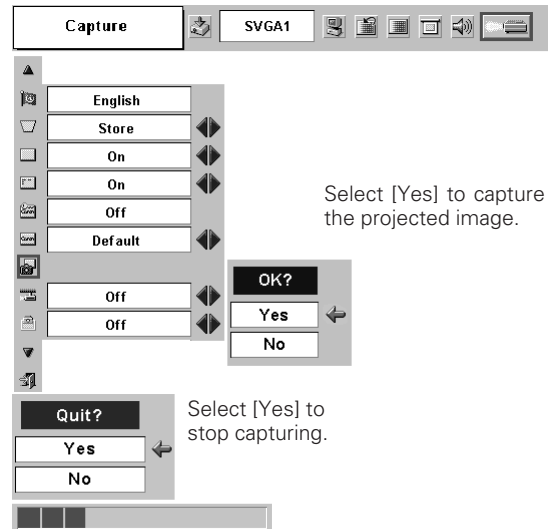

**Ceiling**

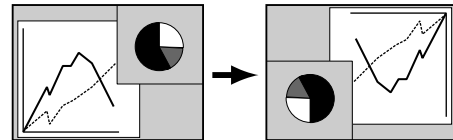

**Rear**

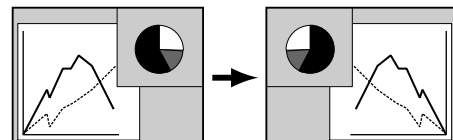



 **Power management**

For reducing power consumption as well as maintaining the lamp life, the Power management function turns off the projection lamp when the input signal is interrupted and no button is pressed for a certain period.

If the input signal is interrupted and no button is pressed for 30 seconds or more, the timer display with the message "No signal" appears on the screen. The count-down of the set time will get started. The count-down time can be set between 1 and 30 minutes. Set the count-down time with Point ◀▶ buttons.

When the count-down time has been elapsed, the lamp will be turned off to cool itself down. The POWER indicator is blinking red during this cooling-off period. The next operation depends on the setting as follows :

- Ready . . . . .When the lamp has been fully cooled down, the POWER indicator changes to green blinking. In this condition, the projection lamp will be turned on if the input signal is reconnected or any button on the top control or remote control unit is pressed.
- Shutdown . . . . .When the lamp has been fully cooled down, the power will be turned off.
- Off . . . . .The Power management function is canceled.

 **On start**



When this function is "On", the projector is automatically turned on just by connecting the AC power cord to a wall outlet. Press the Point ◀▶ button to switch On / Off.

✓ **Note:**

- Be sure to turn the projector off properly (see "Turning Off the Projector" on page 18). If the projector is turned off in the incorrect sequence, such as disconnecting the AC power cord before completing the cool down etc., the On start function does not operate properly.

 **Lamp mode**

This function allows you to change the brightness of the screen.

-  Normal.....normal brightness
-  Auto.....brightness according with the input signal
-  Silent .....lower brightness reduces the lamp power consumption and extends the lamp life. The sound is quiet.

**Power management**



Time left until Lamp off

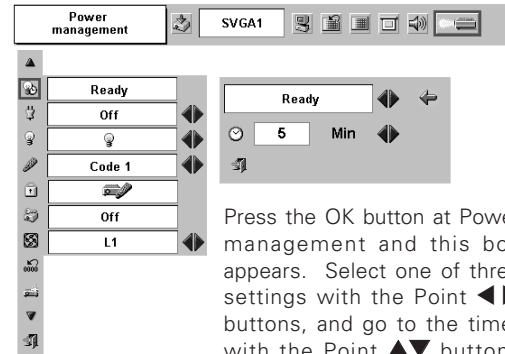

Press the OK button at Power management and this box appears. Select one of three settings with the Point ◀▶ buttons, and go to the timer with the Point ▲▼ buttons and set time with the Point ◀▶ buttons.

 **Remote control**

This projector has two different remote control unit codes; the factory-set normal code (Code 1) and the secondary code (Code 2). This switching function prevents remote control unit interference when operating several projectors or video equipment at the same time.

When operating the projector in "Code 2", both the projector and remote control unit must be switched to "Code 2".

**To change the code of the projector :**

Set the remote control unit in the Setting menu to "Code 2."

**To change the code of the remote control unit :**

Press and hold both MENU and IMAGE buttons on the remote control unit together for 10 seconds or more. After changing the code, make sure the remote control unit operates properly.

To return to the normal code (Code 1), operate both the projector and remote control unit in the ways above again.



**✓ Note :**

- When battery of the remote control unit is replaced, the remote control unit code automatically returns to the normal code (Code 1).

 **Key lock**

This function locks operation of the top control and remote control unit.

It is useful to prevent operation by an unauthorized person.

-  .... not locked.
-  .... lock operation of the top control. To unlock, use the remote control unit.
-  .... lock operation of the remote control unit. To unlock, use the top control.

If the top control accidentally becomes locked and you do not have the remote control unit nearby, disconnect the AC power cord from the AC outlet, and then with pressing the OK button, reinsert the AC power cord. This will cancel the top control lock. Logo PIN code and PIN code will also be canceled.

**Remote Control Unit**

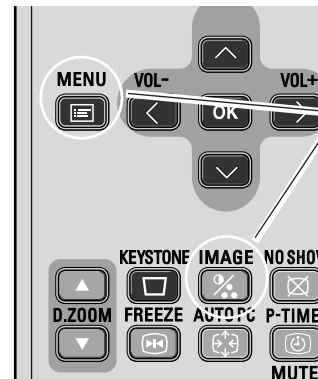

Press and hold MENU and IMAGE buttons for 10 seconds or more.

**Key lock**

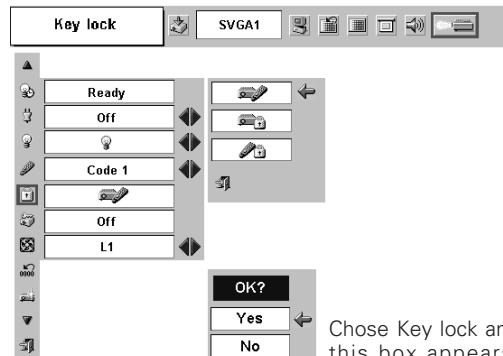

Chose Key lock and this box appears. Select one of these with the Point ▲▼ buttons and select [Yes] to activate it.

**PIN code lock**

This function prevents the projector from being operated by an unauthorized person and provides the following settings for security options.

- Off.....the projector is not locked with the PIN code.
- On1 .....require to enter the PIN code every time turning on the projector.
- On2 .....require to enter the PIN code to operate the projector once the power cord is disconnected; as long as the AC power cord is connected, the projector can be operated without the PIN code.

Whenever to change the PIN code lock setting or the PIN code (the four-digit number), you are required to enter the PIN code. "1234" is set as the initial PIN code at the factory.

**Enter a PIN code**

Select a number by pressing the Point ◀▶ buttons and fix the number with the OK button. The number will change to "\*". If you fixed an incorrect number, move the pointer to "Set" or "Clear" once by pressing the Point ▼ button, then return to "PIN code". Enter the correct number again. Repeat this step to complete entering a four-digit number.

When the four-digit number is fixed, the pointer will automatically move to "Set". Press the OK button so that you can change the following PIN code lock settings.

If you entered an incorrect PIN code, "PIN code" and the number (\*\*\*\*) will turn red and disappear. Enter a correct PIN code all over again.

**To Change the PIN code lock setting**

Select Off, On1, or On2 with the Point ◀▶ buttons and then "Quit" with the Point ▼ button and press the OK button to close the dialog box.

**To Change the PIN code**

The PIN code can be changed to your desired four-digit number. Select "PIN code change" with the Point ▼ button, and press the OK button. The New PIN code input dialog box will appear.

Select a number with the Point ◀▶ buttons and fix the number with the OK button. Repeat it to complete entering a four-digit number. When the four-digit number is fixed, the pointer will automatically move to "Set". Then press the OK button. Be sure to note the new PIN code and keep it at hand.

**✓ Note:**

- If you forget your PIN code and unable to change it, the PIN code can be reset to the factory default setting (1234) according to the following procedures. When you reset the PIN code, the Logo PIN code and Key lock will be reset, as well.
  1. Disconnect the AC Power Cord from the AC outlet.
  2. As pressing the OK button on the projector, connect the AC Power Cord into an AC outlet again. Keep pressing the OK button until the POWER indicator emits. The PIN code will be returned to the factory default setting while the PIN code lock state will remain the same as previous set state.

**PIN code lock**

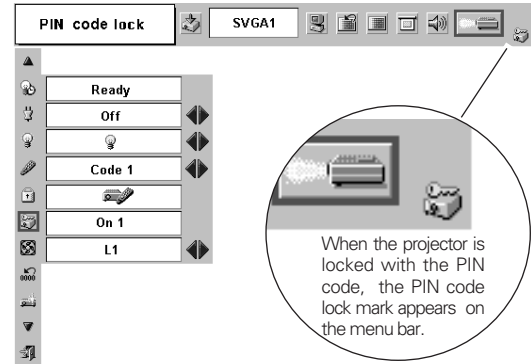

**Enter a PIN code**

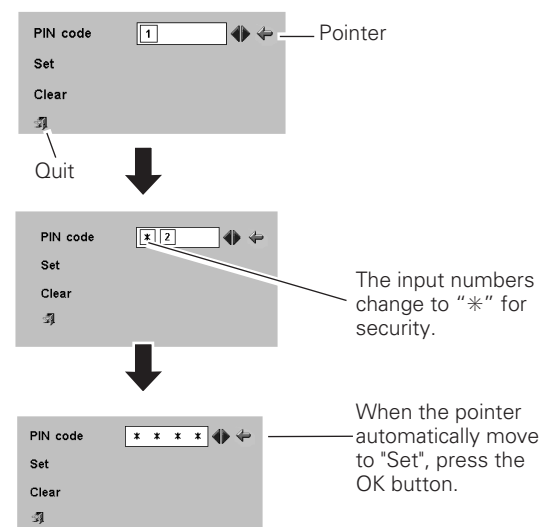

**Change the PIN code lock setting**



**Change the PIN code**

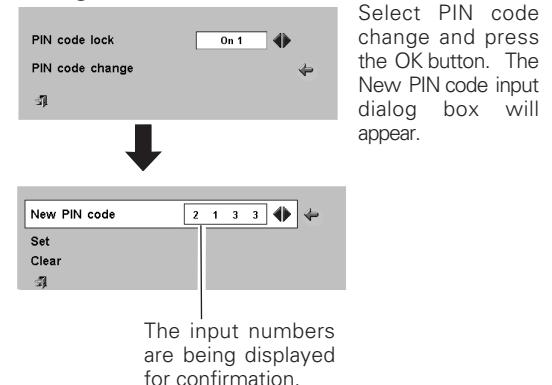

 **Fan**

This function provides you the following alternatives in the cooling fans' operation after turning off the projector. (p18)

- L1 . . . . .normal operation. Cooling the projector for 90 seconds after turning off the projector.
- L2 . . . . .slower operation than the normal (L1) , but takes longer to cool down the projector. Cooling the projector for 120 seconds after turning off the projector.

 **Lamp counter reset**

This function is used to reset the lamp replace counter. When replacing the projection lamp, reset the lamp replace counter by using this function. See page 49 for operation.

 **Factory default**

This function returns all setting values except for the user logo, PIN code lock, Logo PIN code lock and the lamp counter to the factory default settings.

**Fan**

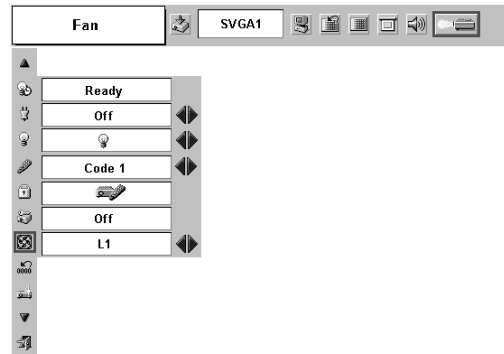

**Factory default**

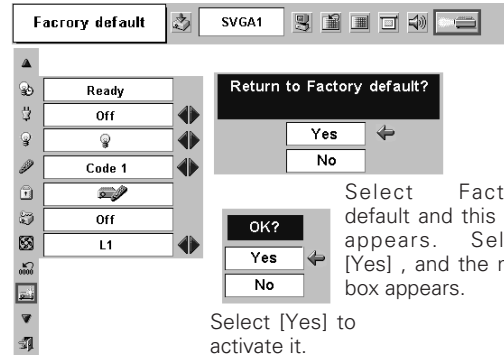

# Maintenance and Cleaning

## Warning Indicator

The WARNING indicator shows the state of the function which protects the projector. Check the state of the WARNING indicator and the POWER indicator to take proper maintenance.

### The projector is shut down and the WARNING indicator is blinking red.

When the temperature inside the projector exceeds the normal temperature, the projector is automatically shut down to protect the inside of the projector. The POWER indicator is blinking and the projector is being cooled down. When the temperature inside the projector returns to normal, the POWER indicator emits red light and the projector can be turned on.

✓ **Note:**

- After the temperature inside the projector returns to normal, the WARNING indicator still continues to blink. When the projector is turned on again, the WARNING indicator stops blinking.

### Then check the matters below:

- Did you provide appropriate space for the projector to be ventilated? Check the installing condition to see if ventilation slots are not blocked.
- Is the projector not installed near the ventilation duct of air-conditioning equipment which may be hot? Install the projector away from the ventilation duct of air-conditioning equipment.
- Are the air filters clean? Clean the air filters periodically. (p46)

### The projector is shut down and the WARNING indicator emits red light.

When the projector detects an abnormal condition, it is automatically shut down to protect the inside and the WARNING indicator emits red light. In this case, disconnect the AC power cord and reconnect it, and then turn the projector on once again for check. If the projector is still turned off and the WARNING indicator emits red light, disconnect the AC power cord and contact the service station for check and repair.



### **CAUTION**

DO NOT LEAVE THE PROJECTOR WITH THE AC POWER CORD CONNECTED UNDER THE ABNORMAL CONDITION. IT MAY RESULT IN FIRE OR ELECTRIC SHOCK.

### TOP CONTROL

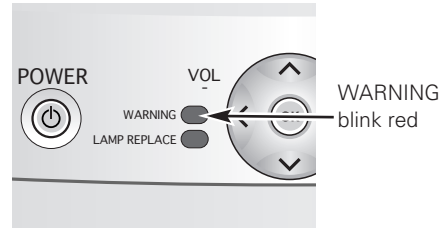

### TOP CONTROL

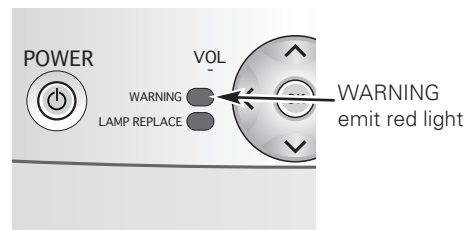

### Cleaning the Air Filters

Air filters prevent dust from accumulating on the surface of the optical elements inside the projector. Should the air filters become clogged with dust particles, it will reduce cooling fans' effectiveness and may result in internal heat build up and adversely affect the life of the projector. Clean the air filters following the steps below.

- 1** Turn off the projector, and disconnect the AC power cord from the AC outlet.
- 2** Turn the projector upside down and remove the air filters by pulling the latches upward.
- 3** Clean the air filters with a brush or rinse them softly.
- 4** When cleaning the air filters by rinsing, dry them well. Replace the air filters properly. Make sure that the air filters are fully inserted.



#### **CAUTION**

Do not operate the projector with the air filters removed. Dust may accumulate on the LCD panel and the projection mirror degrading picture quality. Do not put small parts into the air intake vents. It may result in malfunction of the projector.

#### **RECOMMENDATION**

**We recommend avoiding dusty/smoky environments when operating the projector. Use of the projector in these environments may cause poor image quality.**

When using the projector under dusty or smoky conditions, dust may accumulate on a lens, LCD panels, or optical elements inside the projector. This condition may degrade the quality of a projected image.

When the symptoms above are noticed, contact your authorized dealer or service station for proper cleaning.

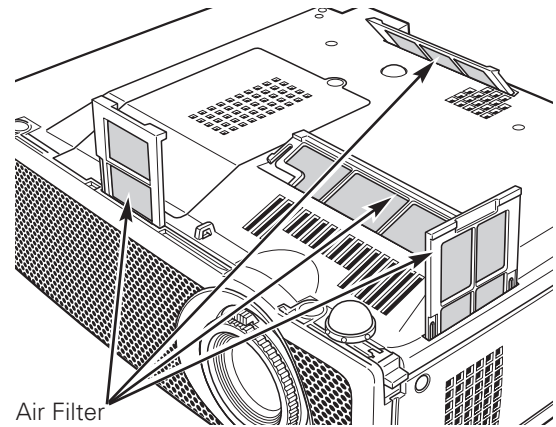

Air Filter  
Pull up and remove.

## Cleaning the Projection Lens

Follow these steps to clean the projection lens.

- 1** Disconnect the AC power cord before cleaning.
- 2** Softly wipe the projection lens with a cleaning cloth that contains a small amount of non-abrasive camera lens cleaner, or use lens cleaning paper or a commercially available air blower to clean the lens. Avoid using an excessive amount of cleaner. Abrasive cleaners, solvents, or other harsh chemicals might scratch the surface.
- 3** When the projector is not in use, replace the lens cover.

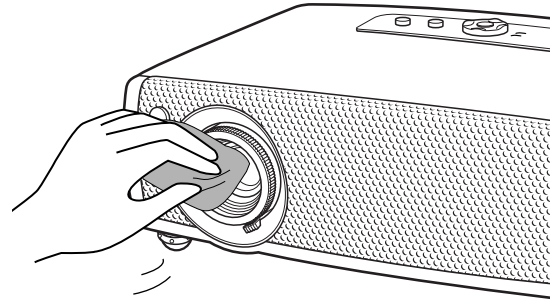

## Cleaning the Projector Cabinet

Follow these steps to clean the projector cabinet.

- 1** Disconnect the AC power cord before cleaning.
- 2** Gently wipe the projector body with a soft, dry cleaning cloth. When it is heavily soiled, use a small amount of mild detergent and finish with a soft, dry cleaning cloth. Avoid using an excessive amount of cleaner. Abrasive cleaners, solvents, or other harsh chemicals might scratch the surface.
- 3** When the projector is not in use, put the projector in an appropriate carrying case to protect it from dust and scratches.

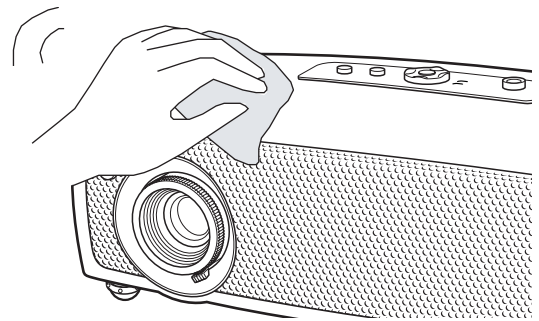

## Attaching the Lens Cover

When moving this projector or while not using it over an extended period of time, replace the lens cover.

- 1** Thread the string through the hole on the lens cover and then tie a knot in the string to secure it in place.
- 2** Thread the other end of the string through the hole at the bottom of the projector. Then pass the lens cover through the resulting loop of the string. Tie a knot in the string to secure it in place.

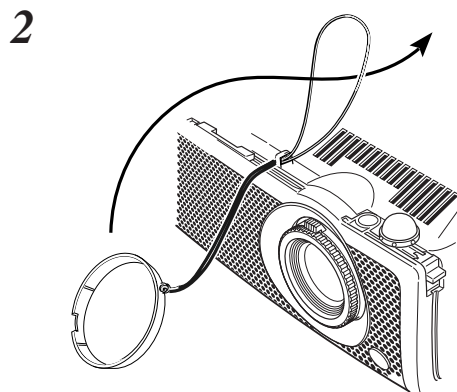
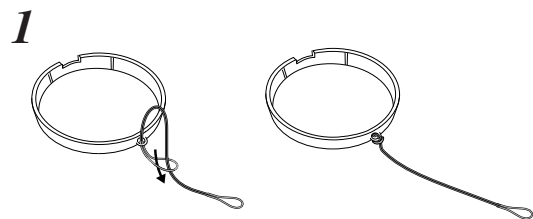

## Lamp Replacement

When the life of the projection lamp of this projector draws to an end, the LAMP REPLACE indicator emits yellow light. If this indicator emits yellow light, replace the lamp with a new one promptly.

This indicator emits yellow light when the life of the projection lamp draws to an end.

### Top Control

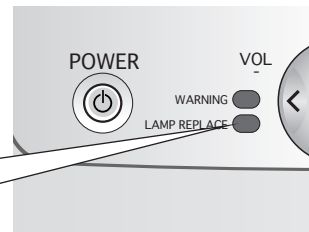

### CAUTION

Allow a projector to cool, for at least 45 minutes before you open the Lamp cover. The inside of the projector can become very hot.



### CAUTION

For continued safety, replace with a lamp of the same type. Do not drop a lamp or touch a glass bulb! The glass can shatter and may cause injury.

Follow these steps to replace the lamp.

- 1** Turn off the projector and disconnect the AC plug. Allow the projector to cool for at least 45 minutes.
- 2** Loosen the screw with a screwdriver, and remove the lamp cover.
- 3** Loosen 2 screws of the lamp with a screwdriver and pull out the lamp by grasping the handle.
- 4** Replace the lamp with a new one and tighten the 2 screws back into position. Make sure that the lamp is set properly. Replace the lamp cover and tighten the screw.
- 5** Connect the AC power cord to the projector and turn on the projector.
- 6** Reset the Lamp replace counter. See "Lamp Replace Counter" on the next page .

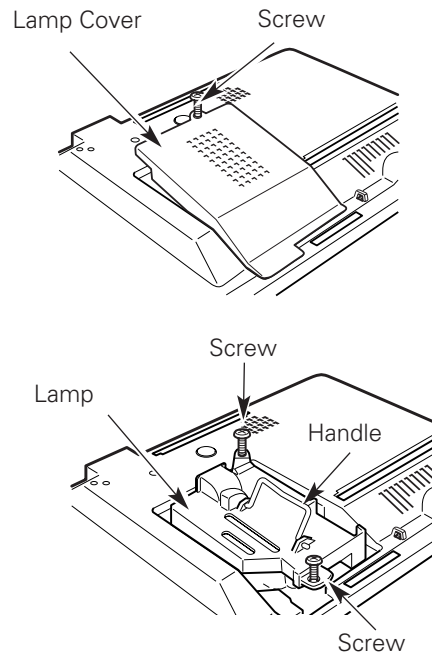

### **ORDER REPLACEMENT LAMP**

Replacement lamp can be ordered through your dealer. When ordering a projection lamp, give the following information to the dealer.

- **Model No. of your projector** : **LV-S4**
- **Replacement Lamp Type No.** : **LV-LP23**  
( 610 317 7038 )



## Lamp Replace Counter

Be sure to reset the lamp replace counter after the lamp is replaced. When the lamp replace counter is reset, the LAMP REPLACE indicator stops emitting yellow light.

- 1 Turn the projector on, press the MENU button and the On-Screen Menu will appear. Press the Point ◀▶ buttons to move the red frame pointer to the Setting Menu icon.
- 2 Press the Point ▼ button to move the red frame pointer to the Lamp counter reset item and then press the OK button. The message "Lamp replace counter reset?" is displayed. Move the pointer to [Yes] and then press the OK button.
- 3 Another confirmation dialog box appears and select [Yes] to reset the Lamp replace counter.

✓ **Note:**

- Do not reset the Lamp replace counter without implementation of lamp replacement. Be sure to reset the Lamp replace counter only after replacing the lamp.

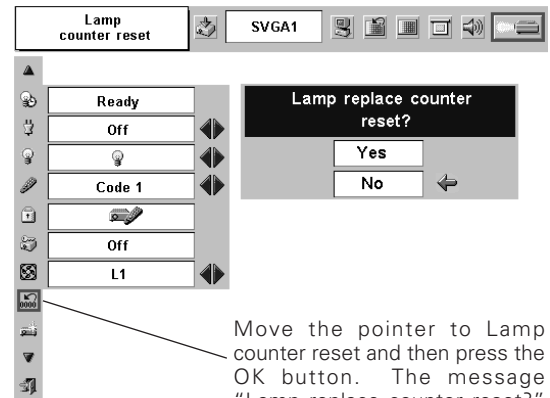

Move the pointer to Lamp counter reset and then press the OK button. The message "Lamp replace counter reset?" is displayed.



## LAMP HANDLING PRECAUTIONS

This projector uses a high-pressure lamp which must be handled carefully and properly. Improper handling may result in accidents, injury, or create a fire hazard.

- Lamp life may differ from lamp to lamp and according to the environment of use. There is no guarantee of the same life for each lamp. Some lamps may fail or terminate their life in a shorter period of time than other similar lamps.
- If the projector indicates that the lamp should be replaced, i.e., if the LAMP REPLACE indicator lights up, replace the lamp with a new one IMMEDIATELY after the projector has cooled down. ( Follow carefully the instructions in the Lamp Replacement section of this manual. ) Continuous use of the lamp with the LAMP REPLACE indicator lighted may increase the risk of lamp explosion.
- A Lamp may explode as a result of vibration, shock or degradation as a result of hours of use as its lifetime draws to an end. Risk of explosion may differ according to the environment or conditions in which the projector and lamp are being used.

### IF A LAMP EXPLODES, THE FOLLOWING SAFETY PRECAUTIONS SHOULD BE TAKEN.

If a lamp explodes, disconnect the projector's AC plug from the AC outlet immediately. Contact an authorized service station for a checkup of the unit and replacement of the lamp. Additionally, check carefully to ensure that there are no broken shards or pieces of glass around the projector or coming out from the cooling air circulation holes. Any broken shards found should be cleaned up carefully. No one should check the inside of the projector except those who are authorized trained technicians and who are familiar with projector service. Inappropriate attempts to service the unit by anyone, especially those who are not appropriately trained to do so, may result in an accident or injury caused by pieces of broken glass.

## Troubleshooting

Before calling your dealer or service center for assistance, check the items below once again.

- Make sure you have properly connected the projector to peripheral equipment as described in "Connecting to a Computer" and "Connecting to Video Equipment" on page 15, 16.
- Make sure all equipment is connected to AC outlet and the power is turned on.
- When you operate the projector with a computer and it does not project an image, restart the computer.

---

**Problem:**

– Solutions

---

**No power**

- Plug the power cord of the projector into the AC outlet.
  - See if the POWER indicator emits red light.
  - Wait 90-120 seconds after the projector is turned off when turning the projector back on. The projector can be turned on after the POWER indicator turns red. (See "Turning Off the Projector" on page 18.)
  - Check the WARNING indicator. If the WARNING indicator emits red light, the projector cannot be turned on. (See "Warning Indicator" on page 45.)
  - Check the projection lamp. (See page 48.)
  - Unlock Key lock for the projector in the Setting Menu. (See page 42.)
- 

**Image is out of focus.**

- Adjust focus of the projector. (See page 19.)
  - Provide proper distance between the projector and the projection screen. (See page 13.)
  - Check the projection lens to see if it needs cleaning. (See page 47.)
  - Moving the projector from a cool to a warm place may result in moisture condensation on the projection lens. In such cases, leave the projector off and wait until condensation evaporates.
- 

**No image**

- Check the connection between your computer or video equipment and the projector. (See page 15, 16)
  - See if the input signal is correctly output from your computer. Some laptop computers may need to change the setting for monitor output when connecting to a projector. See your computer's instruction manual for the setting.
  - It takes about 30 seconds to display an image after turning on the projector.
  - See if the selected system is corresponding with your computer or video equipment. (See page 25 and 33)
  - Select correct input source once again through menu operation. (See page 24, 32)
  - Make sure the temperature is not out of the specified Operating Temperature (41 °F ~ 95 °F (5 °C ~ 35 °C)).
- 

**Image is Left/Right reversed.  
Image is Top/Bottom reversed.**

- Check the Ceiling / Rear item. (See "Setting" on page 40.)
  - Check the Ceiling item. (See "Setting" on page 40.)
- 

**No sound**

- Check audio cable connection from audio input source.
  - Adjust the audio source.
  - Press the Vol + button. (See page 23.)
  - Press the Mute button. (See page 23.)
-

**Some displays are not seen during the operation.**

- Check the Display item. (See “Setting” on page 38.)

---

**PIN code dialog box appears at start-up.** – PIN code lock is being set. Input a PIN code (1234 or numbers you have set). (See “PIN code lock” on page 17 and 43.)

---

**The Remote Control Unit does not work.** – Check the batteries.

- Make sure no obstruction is between the projector and remote control unit.
- Make sure you are not too far from the projector when using the remote control. Maximum operating range is 16.4’ (5m).
- Make sure the code of the remote control unit is conformed to the projector. (See page 42.)
- Unlock Key lock for the remote control unit in the Setting Menu. (See page 42.)

**WARNING :**

**High voltages are used to operate this projector. Do not attempt to open the cabinet.**

If problems still persist after following all operating instructions, contact the dealer where you purchased the projector or the service center. Give the model number and explain about the problem. We will advise you how to obtain service.



The CE Mark is a Directive conformity mark of the European Community (EC).



This symbol on the nameplate means the product is Listed by Underwriters Laboratories Inc. It is designed and manufactured to meet rigid U.L. safety standards against risk of fire, casualty and electrical hazards.

## Menu Tree

### Computer Input / Video Input

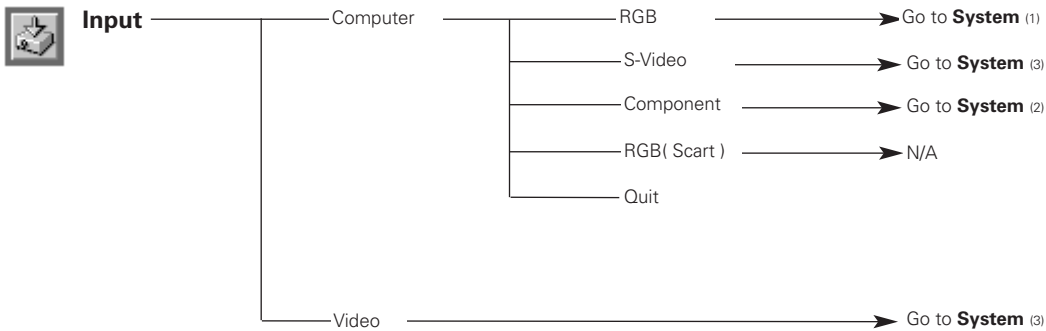

\*N/A --- not applicable

### Sound

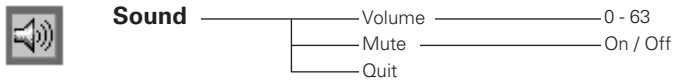

### Computer Input

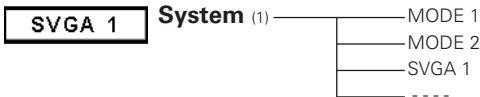

\*Systems displayed in the System Menu vary depending on an input signal.

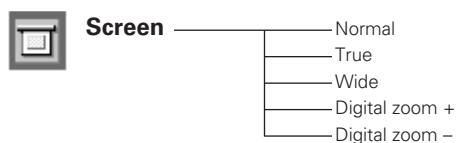
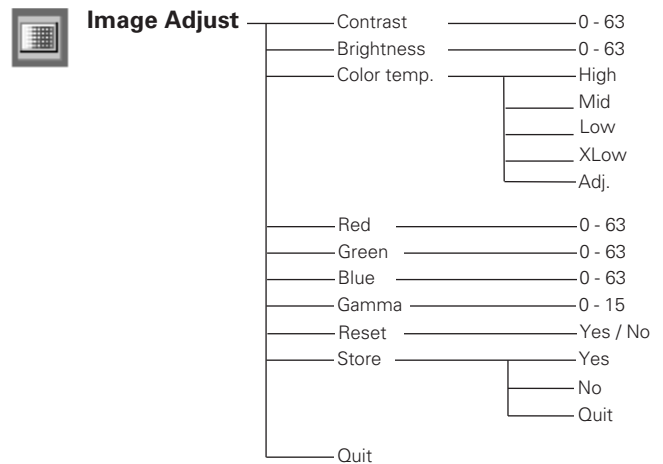
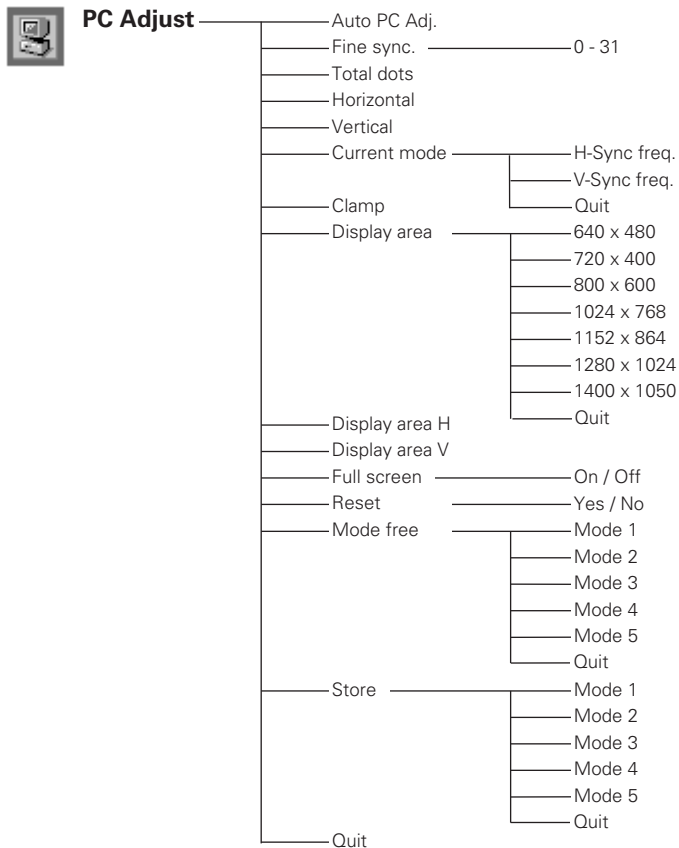
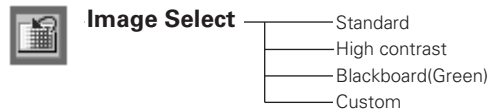

## Video Input

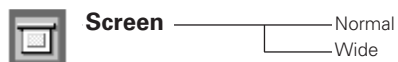
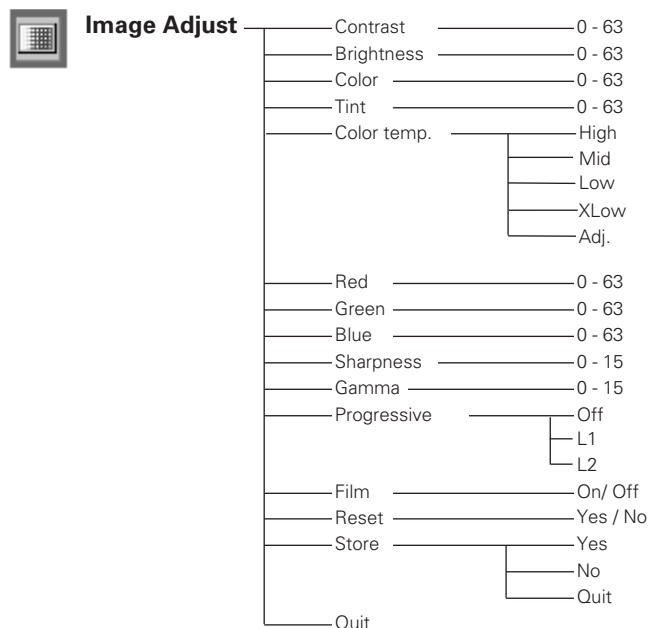
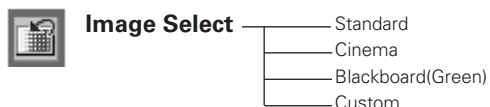
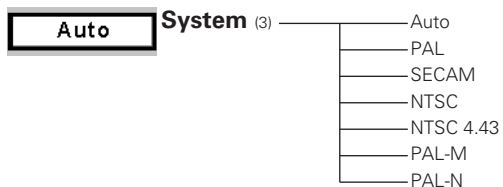
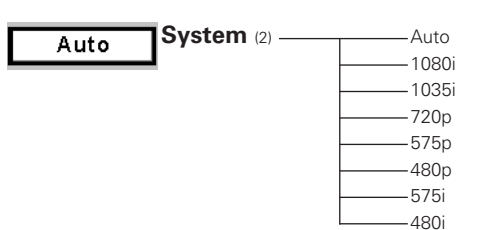

## Setting

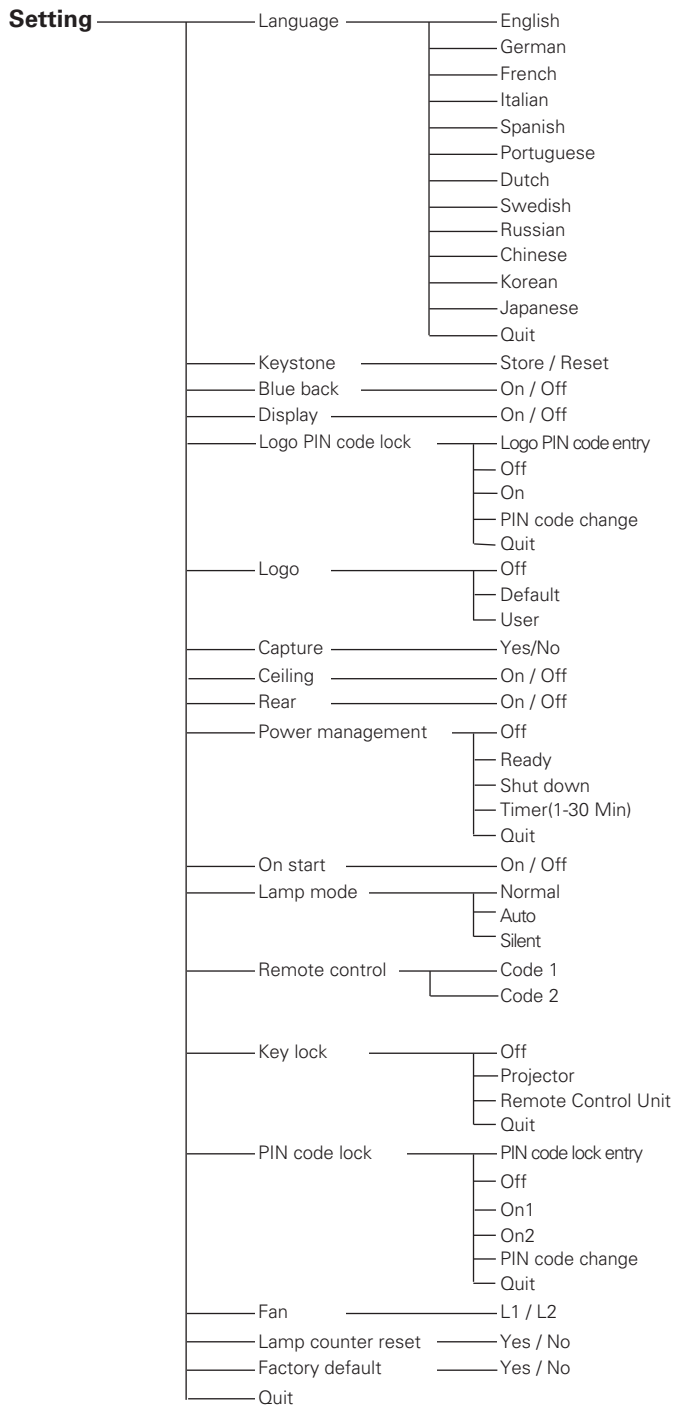

## Indicators and Projector Condition

Check the indicators for projector condition.

Indicators			Projector Condition
POWER red/green	WARNING red	LAMP REPLACE yellow	
●	●	●	The projector is OFF. (The AC power cord is unplugged.)
☉	●	*	The projector is preparing for stand-by or the projection lamp is being cooled down. The projector cannot be turned on until cooling is completed.
◐	●	*	The projector is ready to be turned on with the POWER button.
○	●	*	The projector is operating normally.
☉	●	*	The projector is in the Power management mode.
☉	☉	*	The temperature inside the projector is abnormally high. The projector cannot be turned on. When the projector is cooled down enough and the temperature returns to normal, the POWER indicator emits red light and the projector can be turned on. (The WARNING indicator keeps blinking.) Check and clean the air filters.
◐	☉	*	The projector has been cooled down enough and the temperature returns to normal. When turning on the projector, the WARNING indicator stops blinking. Check and clean the air filters.
●	◐	*	The projector detects an abnormal condition and cannot be turned on. Unplug the AC power cord and plug it again to turn on the projector. If the projector is turned off again, disconnect the AC power cord and contact the dealer or the service center for service and checkup. Do not leave the projector on. It may cause electric shock or a fire hazard.

○ ●●● emit green light    ☉ ●●● blink green    ◐ ●●● emit red light    ☉ ●●● blink red    ● ●●● off

\* When the life of the projection lamp draws to an end, the LAMP REPLACE indicator emits yellow light. When this indicator emits yellow light, replace the projection lamp with a new one promptly. Reset the Lamp replace counter after replacement of the lamp. See page 48 and 49.

## Compatible Computer Specifications

Basically this projector can accept the signal from all computers with the V, H-Frequency below mentioned and less than 100 MHz of Dot Clock.

ON-SCREEN DISPLAY	RESOLUTION	H-Freq. (kHz)	V-Freq. (Hz)	ON-SCREEN DISPLAY	RESOLUTION	H-Freq. (kHz)	V-Freq. (Hz)
VGA 1	640 x 480	31.47	59.88	XGA 2	1024 x 768	68.677	84.997
VGA 2	720 x 400	31.47	70.09	XGA 3	1024 x 768	60.023	75.03
VGA 3	640 x 400	31.47	70.09	XGA 4	1024 x 768	56.476	70.07
VGA 4	640 x 480	37.86	74.38	XGA 5	1024 x 768	60.31	74.92
VGA 5	640 x 480	37.86	72.81	XGA 6	1024 x 768	48.50	60.02
VGA 6	640 x 480	37.50	75.00	XGA 7	1024 x 768	44.00	54.58
VGA 7	640 x 480	43.269	85.00	XGA 8	1024 x 768	63.48	79.35
MAC LC13	640 x 480	34.97	66.60	XGA 9	1024 x 768	36.00	<sup>87.17</sup> (Interlace)
MAC 13	640 x 480	35.00	66.67	XGA 10	1024 x 768	62.04	77.07
480p	————	31.47	59.88	XGA 11	1024 x 768	61.00	75.70
575p	————	31.25	50.00	XGA 12	1024 x 768	35.522	<sup>86.96</sup> (Interlace)
480i	————	15.734	<sup>60</sup> (Interlace)	XGA 13	1024 x 768	46.90	58.20
575i	————	15.625	<sup>50</sup> (Interlace)	XGA 14	1024 x 768	47.00	58.30
SVGA 1	800 x 600	35.156	56.25	XGA 15	1024 x 768	58.03	72.00
SVGA 2	800 x 600	37.88	60.32	MAC 19	1024 x 768	60.24	75.08
SVGA 3	800 x 600	46.875	75.00	MAC 21	1152 x 870	68.68	75.06
SVGA 4	800 x 600	53.674	85.06	SXGA 1	1152 x 864	64.20	70.40
SVGA 5	800 x 600	48.08	72.19	SXGA 11	1152 x 900	61.20	65.20
SVGA 6	800 x 600	37.90	61.03	SXGA 13	1280 x 1024	50.00	<sup>86.00</sup> (Interlace)
SVGA 7	800 x 600	34.50	55.38	SXGA 14	1280 x 1024	50.00	<sup>94.00</sup> (Interlace)
SVGA 8	800 x 600	38.00	60.51	SXGA 17	1152 x 900	61.85	66.00
SVGA 9	800 x 600	38.60	60.31	SXGA 18	1280 x 1024	46.43	<sup>86.70</sup> (Interlace)
SVGA 10	800 x 600	32.70	51.09	720p (HDTV)	————	45.00	60.00
SVGA 11	800 x 600	38.00	60.51	1035i (HDTV)	————	33.75	<sup>60.00</sup> (Interlace)
MAC 16	832 x 624	49.72	74.55	1080i (HDTV)	————	33.75	<sup>60.00</sup> (Interlace)
XGA 1	1024 x 768	48.36	60.00	1080i (HDTV)	————	28.125	<sup>50.00</sup> (Interlace)

## Technical Specifications

### Mechanical Information

Projector Type	Multi-media Projector
Dimensions (W x H x D)	10.63" x 3.27" x 7.76" (270mm x 83.1mm x 197.2mm) (not including Adjustable Feet)
	Net Weight 5.1lbs (2.3 kg)
Feet Adjustment	0° to 8.0°

### Panel Resolution

LCD Panel System	0.5" TFT Active Matrix type, 3 panels
Panel Resolution	800 x 600 dots
Number of Pixels	1,440,000 (800 x 600 x 3 panels)

### Signal Compatibility

Color System	PAL, SECAM, NTSC, NTSC4.43, PAL-M, PAL-N
High Definition TV Signal	480i, 480p, 575i, 575p, 720p, 1035i, and 1080i
Scanning Frequency	H-sync. 15 ~ 80 KHz, V-sync. 50 ~ 100 Hz

### Optical Information

Projection Image Size (Diagonal)	Adjustable from 34" to 200"
Projection Lens	F 1.6 ~ 1.8 lens with f 18.3 mm ~ 21.9 mm with manual zoom and focus
Throw Distance	4.3' ~ 21.3' (1.3m ~ 6.5m)
Projection Lamp	160W UHP Lamp

### Interface

Video Input Jack	RCA Type x 1
Audio Input Jack	Mini Jack (Stereo) x 1
Monitor Out Terminal	(VGA) HDB15 Terminal X 1
Computer / S-Video / Component Input Terminal	(VGA) HDB15 Terminal X 1
Service Port Connector	Mini DIN 8 pin x 1
Audio Output Jack	Mini Jack (stereo) x 1 (Variable)

### Audio

Internal Audio Amp	0.8 W RMS
Built-in Speaker	1 speaker, ø1.3" (32mm)

### Power

Voltage and Power Consumption	AC 100 ~ 120 V (3.6 A Max. Ampere), 50 / 60 Hz (The U.S.A and Canada) AC 200 ~ 240 V (1.8 A Max. Ampere), 50 / 60 Hz (Continental Europe)
-------------------------------	--

### Operating Environment

Operating Temperature	41 °F ~ 95 °F (5 °C ~ 35 °C)
Storage Temperature	14 °F ~ 140 °F (-10°C ~ 60 °C)

### Remote Control Unit

Battery	AAA, SUM-04 or LR03 type x 2
Operating Range	16.4' (5m) / ±30°
Dimensions	2.0" (W) x 0.91" (H) x 4.8" (D) (51.5mm x 23.2mm x 123mm)
Net Weight	2.11 oz (60 g) (including batteries)



## Accessories

---

Owner's Manual  
 AC Power Cord  
 Remote Control Unit and Batteries  
 VGA Cable  
 Lens Cover with String  
 Soft Carrying Bag  
 PIN Code Label

- The specifications are subject to change without notice.
- LCD panels are manufactured to the highest possible standards. Even though 99.99% of the pixels are effective, a tiny fraction of the pixels (0.01% or less) may be ineffective by the characteristics of the LCD panels.
- The On-Screen Menu and figures in this manual may differ slightly from the product.

## Optional Parts

The parts listed below are optionally available. When ordering those parts, give the item name and Model No. to the sales dealer.

	<i>Model No.</i>
<b>COMPONENT-VGA Cable</b>	: LV-CA32
<b>SCART-VGA Cable</b>	: LV-CA31
<b>S-Video-VGA Cable</b>	: LV-CA33
<b>Ceiling Hanger</b>	: LV-CL09
<b>Presentation Remote Control Kit</b>	: LV-RC02

## Configurations of Terminals

### COMPUTER INPUT/S-VIDEO INPUT/COMPONENT INPUT/MONITOR OUTPUT TERMINAL (ANALOG)

Terminal : HDB15-PIN

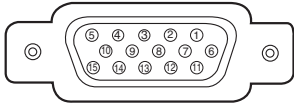

<b>1</b>	Red (R/Cr) Input / Output	<b>9</b>	----
<b>2</b>	Green (G/Y) Input / Output	<b>10</b>	Ground (Vert.sync.)
<b>3</b>	Blue (B/Cb) Input / Output	<b>11</b>	Ground / ----
<b>4</b>	----	<b>12</b>	----
<b>5</b>	Ground (Horiz.sync.)	<b>13</b>	Horiz. sync. Input/Output (Composite H/V sync.)
<b>6</b>	Ground (Red)	<b>14</b>	Vert. sync.
<b>7</b>	Ground (Green)	<b>15</b>	----
<b>8</b>	Ground (Blue)		

### SERVICE PORT CONNECTOR

Terminal : Mini DIN 8-PIN

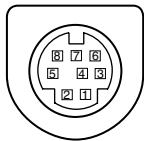

	Serial
<b>1</b>	R X D
<b>2</b>	----
<b>3</b>	----
<b>4</b>	GND
<b>5</b>	RTS / CTS
<b>6</b>	T X D
<b>7</b>	GND
<b>8</b>	GND

## ***PIN code label***

### ***While the projector is locked with the PIN code...***

Put the label below (supplied) on in a prominent place of the projector's body while it is locked with a PIN code.

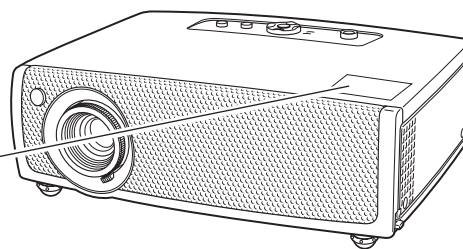



**CANON INC.** 30-2, Shimomaruko 3-chome, Ohta-ku, Tokyo 146-8501, Japan

**CANON U.S.A., INC.**

One Canon Plaza, Lake Success, NY 11042, U.S.A.

**CANON CANADA, INC.**

6390 Dixie Road Mississauga, Ontario L5T 1P7 Canada

**CANON LATIN AMERICA, INC.**

703 Waterford Way Suite 400 Miami, Florida 33126 U.S.A.

**CANON MEXICANA, S.DE R.L.DE C.V.**

Blvd. M. A. Camacho No.138, Piso PB 15, 16 y 17, Col. Lomas de Chapultepec,  
C.P. 11000 México, D.F. México

**CANON EUROPA N.V.**

P.O.Box 2262, 1180 EG Amstelveen, The Netherlands

**CANON COMMUNICATION & IMAGE FRANCE S.A.**

102, Avenue du General de Gaulle, 92250 La Garenne Colombes, France

**CANON (UK) LTD.**

Woodhatch, Reigate, Surrey RH2 8BF, United Kingdom

**CANON DEUTSCHLAND GmbH**

Europark Fichtenhain A 10, 47807 Krefeld, Germany

**CANON ITALIA S.p.A.**

Via Milano 8, I-20097 San Donato Milanese (MI), Italy

**CANON (Schweiz) A.G.**

Industriestrasse 12, 8305 Dietlikon, Switzerland

**CANON BELGIUM N.V./S.A**

Bessenveldstraat 7, 1831 Diegem, Belgium

**CANON GmbH**

Zetschegasse 11, A-1232 Wien, Austria

**CANON ESPANA S.A.**

C/Joaquin Costa 41, 28002 Madrid, Spain

**CANON SVENSKA AB**

Stensättravägen 13, S-127 88 Skarholmen 2, Sweden

**CANON NORGE A/S**

Hallagerbakken 110, P. O. Box 2-33, Holmlia 1201 Oslo 12, Norway

**CANON OY**

Huopalahdentie 24, P.O. Box 1, FIN-00351 Helsinki, Finland

**CANON HONGKONG CO., LTD.**

19/F., The Metropolis Tower, 10 Metropolis Drive, Hunghom, Kln., H. K.

**CANON SINGAPORE PTE. LTD.**

1 HarbourFront Avenue #04-01, Keppel Bay Tower Singapore 098632

**CANON AUSTRALIA PTY. LTD.**

1 Thomas Holt Drive, North Ryde, Sydney, N.S.W.2113, Australia

**CANON NEW ZEALAND LTD.**

Akoranga Business Park, Akoranga Drive, Northcote, Auckland, New Zealand

**CANON DENMARK A/S**

Knud Hoejgaards Vej, DK-2860 Soeborg, Denmark